

Twin systems

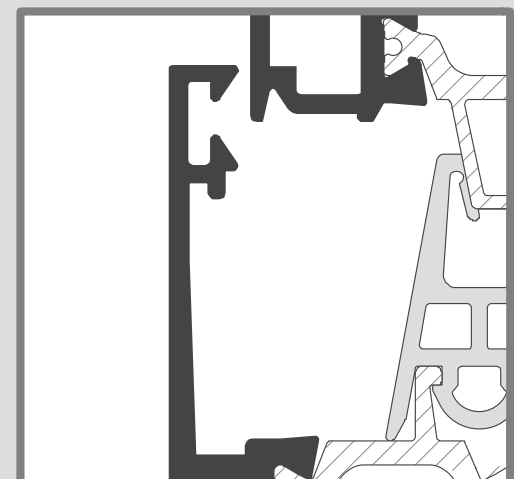

Thermal Windows System

CX 700

Versione 13



Informazioni generali	Gruppo A	Indice generale Caratteristiche alluminio Descrizione tecnica sistema Descrizione tecnica capitolato Collaudi prestazionali
Profilati	Gruppo B	Elenco profilati Profilati scala 1.1
Accessori e Guarnizioni	Gruppo C	Elenco accessori Elenco guarnizioni
Sezioni	Gruppo D	Sezioni principali in scala 1:1 corredate dei relativi accessori
Tipologie	Gruppo E	Principali tipologie di finestre
Collegamento muratura	Gruppo F	Sezione particolareggiata attacco alla muratura
Lavorazioni / Montaggi	Gruppo G	Schemi lavorazioni Frese Attrezzature

PESO PROFILATI

Il peso indicato è quello teorico e potrà variare in funzione delle tolleranze di spessore e dimensionali dei profilati (NORMA UNI EN 12020-2)

LEGA DI ESTRUSIONE

I profilati sono estrusi in lega EN-AW-6060 (UNI EN 573/3)

DIMENSIONI DEI PROFILATI

Le dimensioni indicate sono quelle teoriche, potranno quindi variare in funzione delle tolleranze dimensionali di estrusione (norma UNI EN 12020-2). Questa variabilità che interessa tutti i profilati, può influire, anche se minimamente, sulle dimensioni di taglio e quindi finali del serramento. Anche la verniciatura, aumentando gli spessori, contribuisce a far variare la dimensione dei profilati e, particolarmente, riduce lo spazio nelle sedi di inserimento delle guarnizioni e degli accessori.

DIMENSIONI DI TAGLIO E LAVORAZIONI

Le dimensioni teoriche di taglio e le quote delle lavorazioni indicate nel presente catalogo sono esatte, ovvero matematicamente corrette, in certi casi dovranno, nella pratica, essere adattate in base alla precisione ed al tipo di impostazione delle misure delle macchine utilizzate. È pertanto consigliabile nei primi lavori o nel caso di importanti quantità di serramenti effettuare delle campionature di prova.

PROTEZIONE SUPERFICIALE

Al fine di limitare i processi di corrosione filiforme è importante applicare le seguenti regole:

- utilizzare accessori di assemblaggio in alluminio utilizzare viti in acciaio inox ,
- proteggere le parti tagliate e lavorate con prodotti idonei
- evitare ristagni di condense all'interno dei profilati.

Per la realizzazione di serramenti è necessario attenersi alla tecnologia costruttiva e utilizzare le guarnizioni e gli accessori originali riportati sul catalogo tecnico e al rispetto delle norme, prescrizioni e raccomandazioni vigenti. L'osservanza di quanto sopra determina la garanzia .Su queste basi sono stati realizzati campioni che, collaudati in laboratorio hanno ottenuto i risultati indicati nelle certificazioni. Per il buon funzionamento e la durata degli infissi realizzati con profilati ed accessori del sistema , è necessario effettuare alcune semplici operazioni: una buona pulizia, eliminando residui di calce, cemento e/o altro. È consigliabile peraltro proteggere il manufatto sino al momento della messa in esercizio, lubrificare con olio o grasso neutri le parti in movimento e gli organi di chiusura, controllare il corretto serraggio delle viti e dei grani, controllare gli assetti, registrandoli laddove sono previste regolazioni. Si raccomanda di effettuare queste operazioni almeno con cadenza semestrale. In caso di funzionamento anomalo di qualche componente, evitare assolutamente interventi atti a modificarne le caratteristiche e la sostituzione con ricambi non originali. Ci sembra utile ricordare che interventi di regolazione e/o sostituzione, con particolare riferimento ai meccanismi per oscillo-battente, andranno eseguiti da personale specializzato. Si raccomanda inoltre, in occasione delle operazioni di pulizia, di non utilizzare detergenti che possano deteriorare i trattamenti superficiali, escludendo tassativamente acidi, solventi, materiali abrasivi, spazzole metalliche o comunque in grado di scalfire le superfici, pagliette metalliche e altro.

DIMENSIONI E TIPOLOGIA DEI SERRAMENTI

La valutazione delle dimensioni dei serramenti, richiede la considerazione di vari fattori quali: il momento d'inerzia dei profilati ,le dimensioni e il peso dei tamponamenti (vetri-pannelli),la larghezza e l'altezza delle parti apribili caratteristiche e portate degli accessori,le condizioni e le quantità degli ancoraggi alle opere morte,l'esposizione, ecc...Fattori che sono valutabili e applicabili, grazie alla buona conoscenza dello stato dell'arte, alle informazioni riportate dai cataloghi, manuali tecnici e dalle normative vigenti. Consigliamo, al fine di evitare inutili contestazioni, di consultare il nostro servizio tecnico sistemi, prima di realizzare serramenti che, per dimensione, forma, esposizione e/o altro possono essere ritenuti atipici. Le soluzioni e le combinazioni proposte in questo catalogo, non hanno carattere limitativo, ma presentano solo le situazioni e combinazioni più comunemente riscontrabili nella realtà. Soluzioni e combinazioni diverse, così come l'adozione di componentistica particolare, ad esempio meccanismi per la realizzazione di ante scorrevoli parallele, ante scorrevoli a libro o altro, sono possibili. A questo proposito il nostro servizio tecnico prodotti per l'edilizia può valutare e proporre le soluzioni più idonee.

DESCRIZIONE TECNICA PER CAPITOLATO

I profilati per serramenti saranno in lega di alluminio ENAW 6060 (EN 573-3 e EN 755-2) con stato fisico di fornitura UNI EN 515. I telai fissi e le ante mobili dovranno essere realizzati con profilati ad interruzione di ponte termico a tre camere (profilo interno ed esterno tubolari, collegati tra di loro con barrette in poliammide PA 6.6 rinforzate con fibra di vetro).

INFISSI

Le finestre e le porte finestre dovranno avere un profilato di telaio fisso con profondità minima 70 mm. ed un profilato di anta mobile con profondità minima 78 mm. I profilati di telaio fisso dovranno prevedere, dove necessario, alette incorporate di battuta interna sulla muratura da 22 mm . I profilati di ante mobili dovranno avere un'aletta esterna di battuta per vetro con altezza di 22 mm ed una aletta di battuta interna sul telaio fisso con sormonto di 6 mm. La barretta in poliammide del profilato anta a contatto con la guarnizione di tenuta centrale (giunto aperto), dovrà essere di forma tubolare.

ISOLAMENTO TERMICO

L'interruzione del ponte termico sarà ottenuta da barrette continue in poliammide da 28 mm totale e dovrà garantire un valore di trasmittanza termica per l'infisso $U_w = \dots\dots\dots$ W/m²K. L'assemblaggio dei profilati in alluminio a taglio termico dovrà garantire i valori di scorrimento (T) tra profilati in alluminio e barrette in poliammide previsti dalla direttiva tecnica Europea (UEAtc).

DRENAGGI E VENTILAZIONE

I profilati esterni delle ante mobili dovranno prevedere una gola ribassata per la raccolta delle acque di infiltrazione e di condensa onde poter permettere il libero deflusso delle stesse attraverso apposite asole di scarico. Le barrette in poliammide dovranno avere una conformazione geometrica atta ad evitare eventuale ristagno di acque di infiltrazione e di condensa ed essere perfettamente complanari con le pareti trasversali dei profilati di alluminio.

ACCESSORI DI ASSEMBLAGGIO

Le giunzioni tra profilati orizzontali e verticali dovranno essere perfettamente solidali e ben allineate tra di loro, sia nella parte esterna che interna dei profilati ed unite mediante apposite squadrette a bottone o, in alternativa, in alluminio estruso o pressofuso, con metodo a spino-cianfrinatura od a cianfrinatura totale. Le sezioni dei profilati orizzontali e verticali dovranno essere opportunamente sigillate prima di essere unite con le squadrette. I fermavetri saranno accoppiati a scatto e posizionati nei canali dei profilati in alluminio .

GUARNIZIONI

Tutte le guarnizioni: cingivetro, di tenuta, di battuta.... dovranno essere in elastomero (EPDM). In particolare la guarnizione di tenuta centrale (giunto aperto) dovrà assicurare la continuità perimetrale mediante l'impiego di angoli vulcanizzati preformati incollati alla stessa o in alternativa mediante telai vulcanizzati.

PRESTAZIONI

I serramenti dovranno avere prestazioni di permeabilità all'aria, tenuta all'acqua e resistenza ai carichi del vento conformemente alle norme :

(UNI-EN 12207 - 12208 - 12210 e UNI-EN 1026 - 1027 - 12211)

Permeabilità all'aria: classe _____

Tenuta all'acqua: classe _____

Resistenza al vento: classe _____

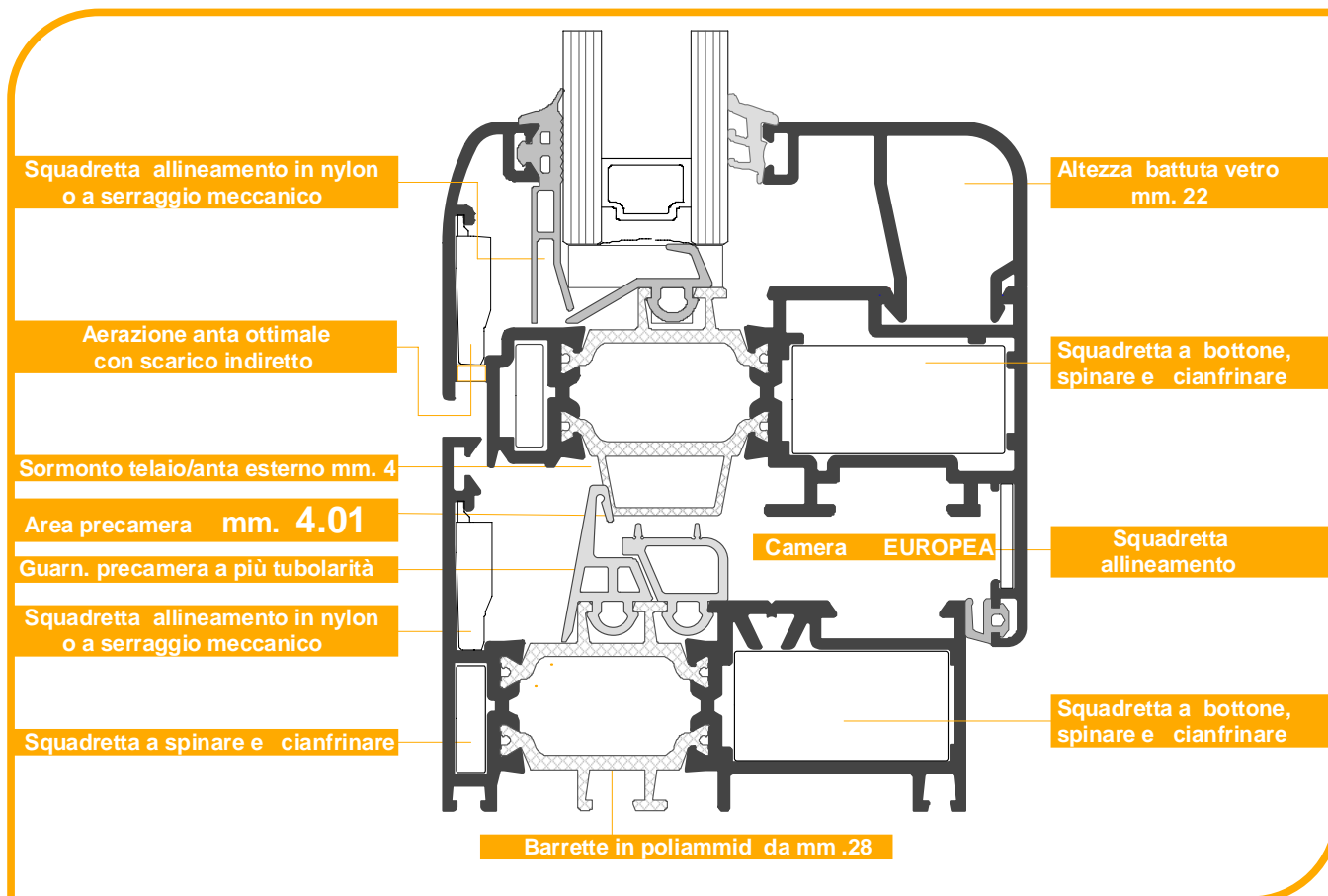

Profilati estrusi lega: ENAW 6060 (EN 573 - 3)
Stato di fornitura: T5 (EN 752 - 2)
Tolleranze dimensioni e spessori: EN 755 - 9
Taglio termico : realizzato con bacchette in poliammide da 18 mm
Tipo di tenuta aria/acqua: Finestre: guarnizione centrale (giunto aperto).
 Porte: guarnizione centrale (giunto aperto) .

Inserimento del vetro : con fermavetro a scatto sia rettangolare che arrotondato, con fermavetro a clips .

Altezza utile alloggiamento vetro: mm. 22
 Possibilità di inserimento volumi di vetro di pannelli con spessori variabili tra mm. 10 e 50.

Dimensioni principali

Telaio fisso : mm. 70
Telaio mobile: mm. 78 (complanare)
Controtelaio : mm. 70
Fuga perimetrale interna ed esterna : mm. 5
Alloggiamento accessori: a Camera Europea spazio 11.5 mm.
Giunzione angolare: con squadrette a bottone, spinare o cianfrinare

Impiego:

Profilati per finestre che consentono la costruzione di infissi ad una, due o più ante a battente, nella versione a giunto aperto o con doppia guarnizione di battuta complanari all'esterno e a sormonto all'interno. Sono possibili anche specchiature fisse, wasistas, anta-ribalta.
 Profilati per porte: consentono la costruzione di porte ad una o due ante, apribili sia all'interno che all'esterno, con sopraluci fissi od apribili e vetrine.

ANALISI TERMICA

Sistema : CX 600

0112/2008

istituto sperimentale per l'edilizia s.p.a. **ISTEDIL**

CAPIFUM V. 22001 - 01121 FROSINONE - VIA S. GIULIO 100/102 - 01121 FROSINONE (FR) - TEL. 0776/220011 - FAX 0776/220012
 C.A.P. 01121 FROSINONE - C.A.P. 01121 FROSINONE - C.A.P. 01121 FROSINONE - C.A.P. 01121 FROSINONE - C.A.P. 01121 FROSINONE
 C.A.P. 01121 FROSINONE - C.A.P. 01121 FROSINONE - C.A.P. 01121 FROSINONE - C.A.P. 01121 FROSINONE - C.A.P. 01121 FROSINONE
 C.A.P. 01121 FROSINONE - C.A.P. 01121 FROSINONE - C.A.P. 01121 FROSINONE - C.A.P. 01121 FROSINONE - C.A.P. 01121 FROSINONE

LINEE GUIDA MODULO TECNICO FASCE ELEM. - Documento redatto da IGED - Modulo per prove di tenuta e permeabilità UNI EN 12207-1
RAPPORTO DI PROVA n° 0112/2008 pag. 2/2

RESISTENZA AL CARICO DEL VENTO (UNI EN 12211)

istituto sperimentale per l'edilizia s.p.a. **ISTEDIL**

CAPIFUM V. 22001 - 01121 FROSINONE - VIA S. GIULIO 100/102 - 01121 FROSINONE (FR) - TEL. 0776/220011 - FAX 0776/220012
 C.A.P. 01121 FROSINONE - C.A.P. 01121 FROSINONE - C.A.P. 01121 FROSINONE - C.A.P. 01121 FROSINONE - C.A.P. 01121 FROSINONE
 C.A.P. 01121 FROSINONE - C.A.P. 01121 FROSINONE - C.A.P. 01121 FROSINONE - C.A.P. 01121 FROSINONE - C.A.P. 01121 FROSINONE

LINEE GUIDA MODULO TECNICO FASCE ELEM. - Documento redatto da IGED - Modulo per prove di tenuta e permeabilità UNI EN 12207-1
RAPPORTO DI PROVA n° 0112/2008 Guidoni a M. 24/01/2008

Risultato delle prove di permeabilità all'aria, tenuta all'acqua e resistenza al vento eseguite il giorno 18/01/2008, su un campione di infisso a due ante consegnato in data 18/01/2008.

Le caratteristiche geometriche e strutturali del campione risultano nella descrizione allegata, fornita dal Committente, che costituisce parte integrante del presente rapporto di prova.

Committente : RALOX S.r.l.
 - Ferentino - (FR)

DATI DICHIARATI

Denominazione : CX 600
 Tipo apertura : battente
 Struttura infisso : alluminio
 Dimensioni (mm) : 1130x1355 (totali) ; 1042x1267 (ap. bil.)

MODALITA' E RISULTATO DELLE PROVE

Condizioni ambientali : 19 °C - 30% U.R.

PERMEABILITA' ALL'ARIA (UNI EN 12207) Area totale m² 1,5 - Gocce aperte ml 5,9

Pascal	m ³ /h	m ³ /hm ²	m ³ /hml
50	0,0	0,0	0,0
100	0,2	0,1	0,0
150	1,7	1,1	0,3
200	2,4	1,6	0,4
250	2,6	1,7	0,4
300	2,7	1,8	0,5
450	3,5	2,3	0,6
600	4,5	3,0	0,8

Classificazione secondo UNI EN 12207 **Classe 4**

TENUTA ALL'ACQUA (UNI EN 1027 - Metodo A)

Fino al raggiungimento della pressione di prova richiesta di 900 Pa, non si è manifestata alcuna infiltrazione di acqua.

Classificazione secondo UNI EN 12208 **Classe E900**

vento più deformante (mm) - 1220

pressione P1 (Pa)		-2000		0	
residuo	Ac	Ac	Ac	A residuo	A residuo
0,2	0,0	-2,2	-1,3		
residuo	Mo	Mo	Mo	B residuo	B residuo
0,2	0,0	-3,8	-1,2		
residuo	Bo	Bo	Bo	B residuo	B residuo
0,3	0,0	-3,4	-1,2		

Fp -1,0

1/200 B,1 <1/300 C,1

Classe **C5**

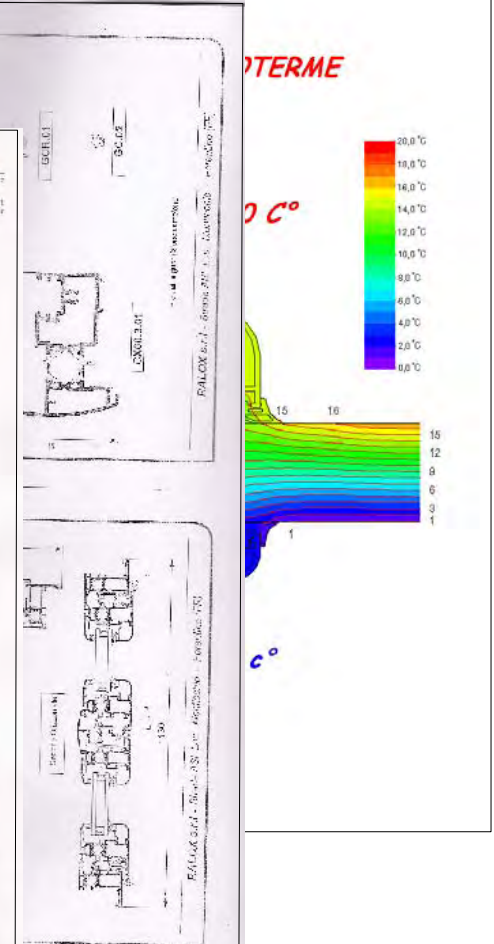

Per il concetto di similar design relativo alla norma di prodotto EN 14351-1 il presente certificato è esteso alla serie CX 700



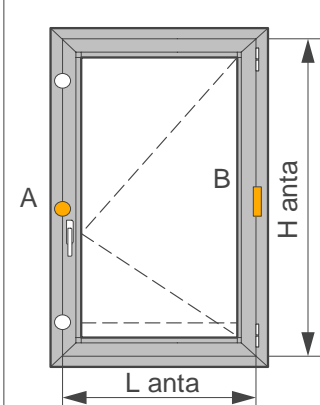
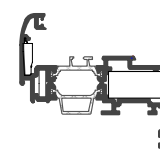
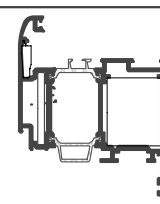

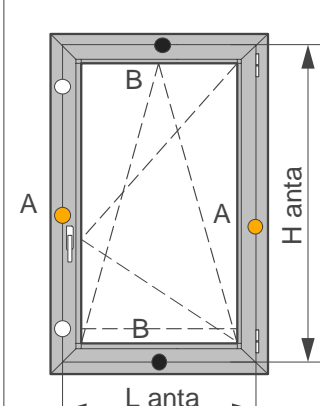
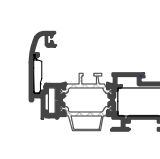
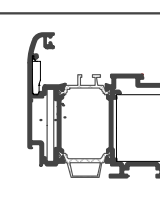

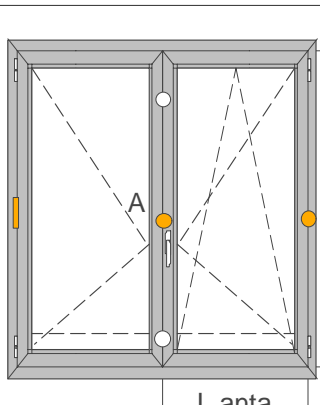
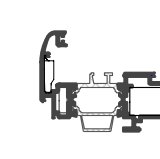
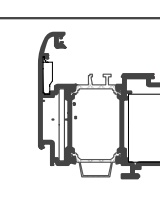

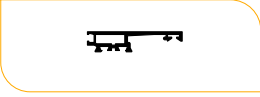
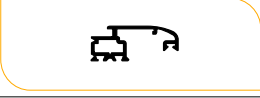
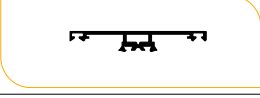
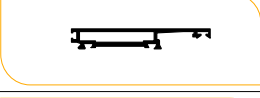
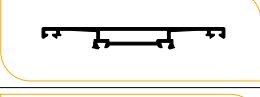

Permeabilità all' Aria UNI EN 12207 Classe 4	Permeabilità all' Acqua UNI EN 12208 Classe E 900	Resistenza al Vento UNI EN 12210 Classe C5	Coefficiente Trasmissione Termica UNI EN 10077.2 Uf 2.26 w/m2k
---	--	---	---

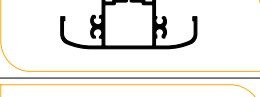

Dimensione max anta	Finestra a 1 anta	Profilati	Punti chiusura supplementari
Finestra 1200 mm x 1400 mm			A ● B
Finestra 1200 mm x 1600 mm			A ● B
Porta finestra 800 mm x 2100 mm			A ● B
Finestra 1200 mm x 1500 mm			A ● B
Finestra 1200 mm x 1800 mm			A ● B
Porta finestra 900 mm x 2300 mm			A ● B

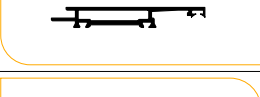
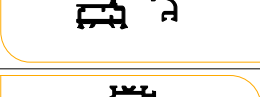





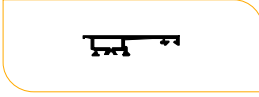
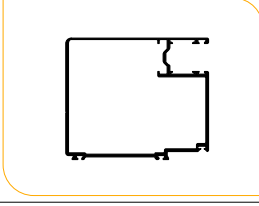

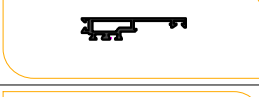
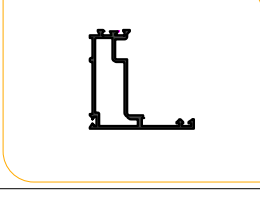
Dimensione max anta	Finestra ad anta-ribalta	Profilati	Punti chiusura supplementari
Finestra 1200 mm x 1400 mm			A ● A ● B ● B ●
Finestra 1200 mm x 1700 mm			A ● A ●
Porta finestra 800 mm x 2100 mm			A ● A ● B ● B ●
Finestra 1200 mm x 1600 mm			A ● A ●
Finestra 1300 mm x 2000 mm			A ● A ● B ● B ●
Porta finestra 900 mm x 2300 mm			A ● A ●



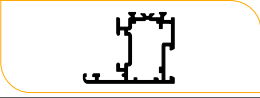

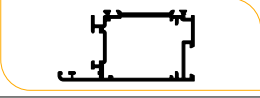
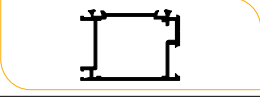
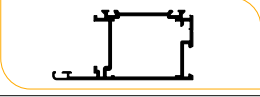
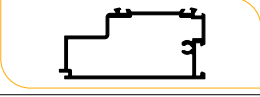
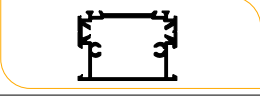
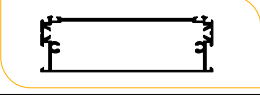
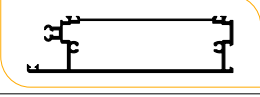



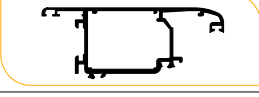

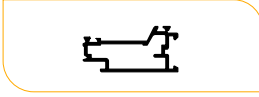
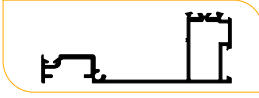
Dimensione max anta	Finestra ad anta-ribalta	Profilati	Punti chiusura supplementari
Finestra 700 mm x 1400 mm			A ● B
Finestra 700 mm x 1500 mm			A ● B
Porta finestra 700 mm x 2100 mm			A ● B
Finestra 900 mm x 1600 mm			A ● B
Finestra 900 mm x 1800 mm			A ● B
Porta finestra 800 mm x 2300 mm			A ● B

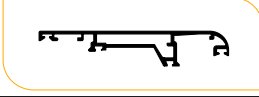
* I valori sopra riportati possono variare in funzione dell'accessorio usato e della zona climatica di ubicazione dell'infisso.

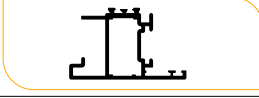
Profilo	Sezione	Peso Kg/ml.	Perim. mm.	Sup. vista mq/ml.
RC 001		0.419	172	0.055
RC 002		0.512	207	0.045
RC 003		0.533	230	0.082
RC 004		0.613	220	0.079
RC 005		0.720	278	0.106
RC 006		0.720	255	0.069
RC 007		0.803	306	0.106
RC 008		1.376	430	0.168
RC 009		0.978	335	0.098
RC 010		0.981	306	0.087
RC 011		0.685	237	0.079
RC 012		0.637	239	0.054
RC 013		0.681	199	0.030
RC 014		1.758	481	0.186
RC 018		1.432	541	0.181
RC 019		0.272	90	-

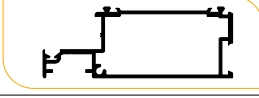
Profilo	Sezione	Peso Kg/ml.	Perim. mm.	Sup. vista mq/ml.
RC 020		0.410	166	0.056
RC 021		1.679	466	0.146
RC 022		1.323	267	0.105
RC 026		0.235	89	0.019
RC 027		0.475	182	0.055
RC 028		0.849	279	0.055

Profilo	Sezione	Peso Kg/ml.	Perim. mm.	Sup. vista mq/ml.
RE 401		0.650	190	0.028
RE 402		0.729	255	0.055
RE 403		0.780	268	0.052
RE 404		0.557	209	0.072
RE 405		0.696	202	0.028
RE 406		1.000	316	0.076
RE 407		0.850	246	0.052
RE 408		0.960	310	0.076
RE 409		1.068	269	0.074
RE 410		1.045	237	0.052
RE 411		1.580	361	0.114
RE 412		1.690	462	0.134
RE 413		0.902	347	0.094
RE 414		1.134	395	0.118
RE 415		0.916	302	0.058
RE 416		1.118	401	0.108

Profilo	Sezione	Peso Kg/ml.	Perim. mm.	Sup. vista mq/ml.
RE 417		0.677	193	0.040
RE 418		1.037	398	0.075
RE 419		1.275	445	0.050
RE 420		0.873	332	0.113
RE 421		1.003	282	0.064
RE 422		0.840	329	0.072
RE 423		0.729	189	0.028
RE 424		0.553	174	0.007
RE 425		1.230	371	0.075
RE 427		0.883	325	0.100
RE 428		0.822	297	0.086
RE 429		0.978	356	0.116
RE 430		0.464	208	0.027

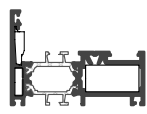

CX70.101				Tavola
Telaio ad L piccolo				
Peso	kg/ml.	1.287		
Jx	24.98 cm4	Wx 6.61 cm3		
Jy	5.28 cm4	Wy 1.64 cm3		

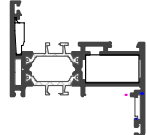
CX70.102				Tavola
Telaio a Z piccolo				
Peso	kg/ml.	1.366		
Jx	29.80 cm4	Wx 8.44 cm3		
Jy	8.40 cm4	Wy 2.28 cm3		

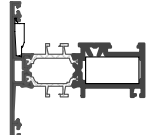
CX70.103				Tavola
Telaio a T piccolo				
Peso	kg/ml.	1.401		
Jx	28.59 cm4	Wx 7.03 cm3		
Jy	8.96 cm4	Wy 2.43 cm3		

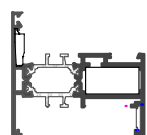
CX70.104				Tavola
Telaio ad h piccolo-soglia				
Peso	kg/ml.	1.480		
Jx	34.19 cm4	Wx 9.08 cm3		
Jy	11.46 cm4	Wy 3.05 cm3		

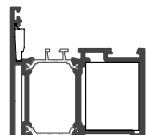
CX70.105				Tavola
Telaio ad L grande				
Peso	kg/ml.	1.681		
Jx	35.96 cm4	Wx 9.31 cm3		
Jy	20.35 cm4	Wy 4.58 cm3		

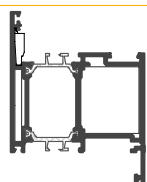
CX70.106				Tavola
Telaio a Z grande				
Peso	kg/ml.	1.791		
Jx	41.82 cm4	Wx 11.43 cm3		
Jy	26.76 cm4	Wy 5.49 cm3		

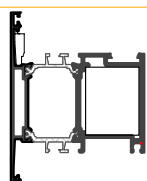
CX70.107				Tavola
Telaio a T grande				
Peso	kg/ml.	1.788		
Jx	38.46 cm4	Wx 9.69 cm3		
Jy	27.36 cm4	Wy 5.62 cm3		

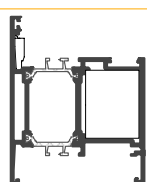
CX70.108				Tavola
Telaio ad h grande				
Peso	kg/ml.	1.898		
Jx	45.35 cm4	Wx 11.88 cm3		
Jy	32.93 cm4	Wy 6.61 cm3		

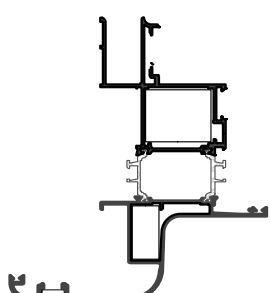
CX70.109				Tavola
Telaio per capannoni				
Peso	kg/ml.	2.887		
Jx	200.60 cm4	Wx 23.57 cm3		
Jy	85.16 cm4	Wy 11.55 cm3		

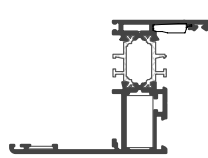
CX70.110				Tavola
Telaio a Z aletta battuta 54 mm.				
Peso	kg/ml.	1.520		
Jx	35.50 cm4	Wx 9.04 cm3		
Jy	23,22 cm4	Wy 3,71 cm3		

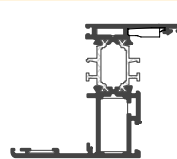
CX70.111				Tavola
Telaio a Z aletta battuta 40 mm.				
Peso	kg/ml.	1.459		
Jx	33.39 cm4	Wx 8.83cm3		
Jy	15,00 cm4	Wy 2,91 cm3		

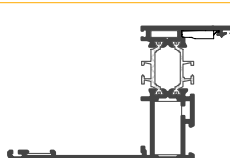
CX70.112				Tavola
Telaio a Z aletta battuta 70 mm.				
Peso	kg/ml.	1.616		
Jx	41.05 cm4	Wx 9.58 cm3		
Jy	37.52 cm4	Wy 5,05 cm3		

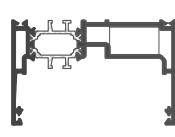
XX70.113				Tavola
Telaio di compensazione				
Peso	kg/ml.	1.542		
Jx	53.42 cm4	Wx 12.40 cm3		
Jy	10,98 cm4	Wy 3,04 cm3		

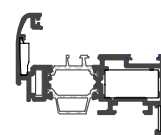
CX70.201				Tavola
Anta tonda piccola c/fermavetro				
Peso	kg/ml.	1.528		
Jx	37.73 cm4	Wx 9.46 cm3		
Jy	9.96 cm4	Wy 2.80 cm3		

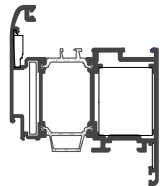

CX70.202			Tavola
Anta tonda grande c/fermavetro			
Peso	kg/ml. 1.956		
Jx	51.50 cm4 Wx 13.13 cm3		
Jy	31.00 cm4 Wy 6.51 cm3		

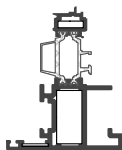
CX70.303			Tavola
Riporto/inversione bilico			
Peso	kg/ml. 1.367		
Jx	26.05 cm4 Wx 5.51 mm3		
Jy	6.92 cm4 Wy 2.10 mm3		

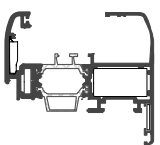
CX70.203			Tavola
Anta tonda piccola v/infilare			
Peso	kg/ml. 1.650		
Jx	42.53 cm4 Wx 9.93 cm3		
Jy	14.47 cm4 Wy 3.76 cm3		

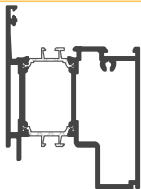
CX70.401			Tavola
Soprazoccolo			
Peso	kg/ml. 1.971		
Jx	41.99 cm4 Wx 11.96 mm3		
Jy	39.08 cm4 Wy 7.72 mm3		

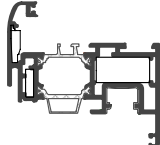
CX70.204			Tavola
Anta tonda piccola f/nastro			
Peso	kg/ml. 1.789		
Jx	47.57 cm4 Wx 11.87 cm3		
Jy	14.63 cm4 Wy 3.71 cm3		

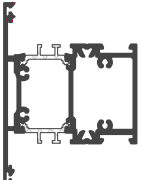
CX70.402			Tavola
Traverso mm.96			
Peso	kg/ml. 2.066		
Jx	43.81 cm4 Wx 11.08 mm3		
Jy	31.45 cm4 Wy 6.55 mm3		

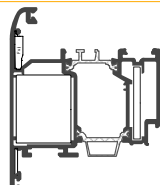
CX70.205			Tavola
Anta apertura esterna			
Peso	kg/ml. 2.039		
Jx	52.27 cm4 Wx 12.09 cm3		
Jy	33.26 cm4 Wy 6.87 cm3		

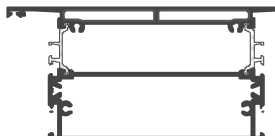
CX70.403			Tavola
Fascia mm. 158			
Peso	kg/ml. 3.174		
Jx	73.53 cm4 Wx 18.10 cm3		
Jy	190.58 cm4 Wy 24.12 cm3		

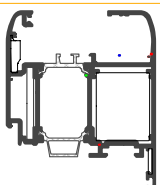
CX70.206			Tavola
Anta tonda grande v/infilare			
Peso	kg/ml. 2.090		
Jx	56.75 cm4 Wx 13.79 cm3		
Jy	39.71 cm4 Wy 7.83 cm3		

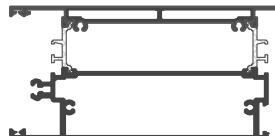
CX70.404			Tavola
Zoccolo mm. 158			
Peso	kg/ml. 3.284		
Jx	79.47 cm4 Wx 20.25 cm3		
Jy	212.70 cm4 Wy 25.47 cm3		

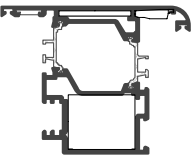
CX70.207			Tavola
Anta apertura bilico			
Peso	kg/ml. 2.086		
Jx	54.02 cm4 Wx 11.88cm3		
Jy	37.93 cm4 Wy 7.45 cm3		

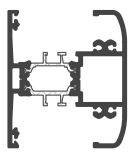
XX70.405			Tavola
Traverso v/infilare mm. 96			
Peso	kg/ml. 1.729		
Jx	20.40 cm4 Wx 5.66 cm3		
Jy	31.96 cm4 Wy 9.41 cm3		

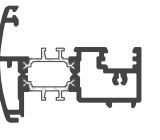
CX70.301			Tavola
Riporto tondo			
Peso	kg/ml. 1.471		
Jx	33.71 cm4 Wx 8.34 cm3		
Jy	8.21 cm4 Wy 2.33 cm3		

XX70.406			Tavola
Traverso v/infilare mm. 158			
Peso	kg/ml. 3.352		
Jx	70.30 cm4 Wx 20.98 cm3		
Jy	231.32 cm4 Wy 29.28 cm3		

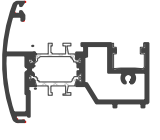
XX70.302			Tavola
Riporto tondo f/nastro			
Peso	kg/ml. 1.462		
Jx	34.52 cm4 Wx 8.33 cm3		
Jy	9.49 cm4 Wy 2.59 cm3		

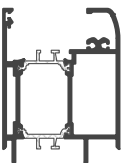
XX70.407			Tavola
Soprazoccolo v/infilare mm. 74			
Peso	kg/ml. 1.884		
Jx	33.98 cm4 Wx 10.92 cm3		
Jy	30.61 cm4 Wy 7.44 cm3		

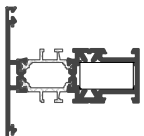
CX70.408			Tavola
Traverso piccolo mm. 72			
Peso	kg/ml. 1.480		
Jx	28.98 cm ⁴ Wx 7.23 cm ³		
Jy	9.52 cm ⁴ Wy 2.64 cm ³		

CX70.527			Tavola
Fermavetro diritto mm. 18			
Peso	kg/ml. 0.290		
Jx	000.00 cm ⁴ Wx 000.00 cm ³		
Jy	000.00 cm ⁴ Wy 000.00 cm ³		

CX70.409			Tavola
Soglia bassa			
Peso	kg/ml. 0.808		
Jx	14.28 cm ⁴ Wx 3,91 cm ³		
Jy	0,60 cm ⁴ Wy 0,41 cm ³		

CX70.528			Tavola
Fermavetro diritto mm. 22			
Peso	kg/ml. 0.307		
Jx	000.00 cm ⁴ Wx 000.00 cm ³		
Jy	000.00 cm ⁴ Wy 000.00 cm ³		

CX70.521			Tavola
Fermavetro tondo mm. 14			
Peso	kg/ml. 0.266		
Jx	000.00 cm ⁴ Wx 000.00 cm ³		
Jy	000.00 cm ⁴ Wy 000.00 cm ³		

CX70.529			Tavola
Fermavetro diritto mm. 26			
Peso	kg/ml. 0.327		
Jx	000.00 cm ⁴ Wx 000.00 cm ³		
Jy	000.00 cm ⁴ Wy 000.00 cm ³		

CX70.522			Tavola
Fermavetro tondo mm. 18			
Peso	kg/ml. 0.277		
Jx	000.00 cm ⁴ Wx 000.00 cm ³		
Jy	000.00 cm ⁴ Wy 000.00 cm ³		

CX70.530			Tavola
Fermavetro diritto mm. 30			
Peso	kg/ml. 0.362		
Jx	000.00 cm ⁴ Wx 000.00 cm ³		
Jy	000.00 cm ⁴ Wy 000.00 cm ³		

CX70.523			Tavola
Fermavetro tondo mm. 22			
Peso	kg/ml. 0.294		
Jx	000.00 cm ⁴ Wx 000.00 cm ³		
Jy	000.00 cm ⁴ Wy 000.00 cm ³		

CX70.531			Tavola
Fermavetro tondo mm. 35			
Peso	kg/ml. 0.370		
Jx	000.00 cm ⁴ Wx 000.00 cm ³		
Jy	000.00 cm ⁴ Wy 000.00 cm ³		

CX70.524			Tavola
Fermavetro tondo mm. 26			
Peso	kg/ml. 0.314		
Jx	000.00 cm ⁴ Wx 000.00 cm ³		
Jy	000.00 cm ⁴ Wy 000.00 cm ³		

CX70.532			Tavola
Fermavetro diritto mm. 35			
Peso	kg/ml. 0.383		
Jx	000.00 cm ⁴ Wx 000.00 cm ³		
Jy	000.00 cm ⁴ Wy 000.00 cm ³		

CX70.525			Tavola
Fermavetro tondo mm. 30			
Peso	kg/ml. 0.350		
Jx	000.00 cm ⁴ Wx 000.00 cm ³		
Jy	000.00 cm ⁴ Wy 000.00 cm ³		

CX70.533			Tavola
Fermavetro diritto mm. 5			
Peso	kg/ml. 0.252		
Jx	000.00 cm ⁴ Wx 000.00 cm ³		
Jy	000.00 cm ⁴ Wy 000.00 cm ³		

CX70.526			Tavola
Fermavetro diritto mm. 14			
Peso	kg/ml. 0.279		
Jx	000.00 cm ⁴ Wx 000.00 cm ³		
Jy	000.00 cm ⁴ Wy 000.00 cm ³		

XX70.601			Tavola
Gocciolatoio			
Peso	kg/ml. 0.269		
Jx	000.00 cm ⁴ Wx 000.00 cm ³		
Jy	000.00 cm ⁴ Wy 000.00 cm ³		

XX70.602			Tavola
Porta spazzolino			
Peso	kg/ml. 0.372		
Jx	000.00 cm ⁴ Wx 000.00 cm ³		
Jy	000.00 cm ⁴ Wy 000.00 cm ³		

XX70.603			Tavola
Soglia piatta da mm. 5			
Peso	kg/ml. 0.275		
Jx	000.00 cm ⁴ Wx 000.00 cm ³		
Jy	000.00 cm ⁴ Wy 000.00 cm ³		

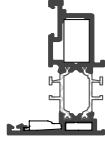
CX70.604			Tavola
Inversione di battuta			
Peso	kg/ml. 1.195		
Jx	16.97 cm ⁴ Wx 5.83 cm ³		
Jy	4.77 cm ⁴ Wy 1.50 cm ³		

CX70.605			Tavola
Astina			
Peso	kg/ml. 0.146		
Jx	000.00 cm ⁴ Wx 000.00 cm ³		
Jy	000.00 cm ⁴ Wy 000.00 cm ³		

XX70.606			Tavola
Scivolo esterno soglia bassa			
Peso	kg/ml. 0.322		
Jx	0,00 cm ⁴ Wx 0,00 cm ³		
Jy	0,00 cm ⁴ Wy 0,00 cm ³		

XX70.607			Tavola
Scivolo interno soglia bassa			
Peso	kg/ml. 0.224		
Jx	0,00 cm ⁴ Wx 0,00 cm ³		
Jy	0,00 cm ⁴ Wy 0,00 cm ³		

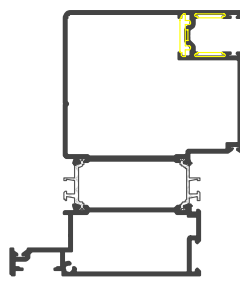
CX70.701			Tavola
Spalla laterale chiusa			
Peso	kg/ml. 3.134		
Jx	260.63 cm ⁴ Wx 34.86 cm ³		
Jy	136.59 cm ⁴ Wy 20.42 cm ³		

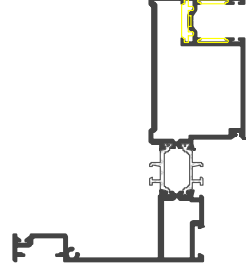
CX70.702			Tavola
Spalla laterale aperta			
Peso	kg/ml. 2.523		
Jx	222.35 cm ⁴ Wx 28.56 cm ³		
Jy	91.91 cm ⁴ Wy 11.55 cm ³		

XX70.703			Tavola
Traverso superiore monoblocco			
Peso	kg/ml. 0.791		
Jx	000.00 cm ⁴ Wx 000.00 cm ³		
Jy	000.00 cm ⁴ Wy 000.00 cm ³		

XX70.704			Tavola
Coprivite			
Peso	kg/ml. 0.135		
Jx	000.00 cm ⁴ Wx 000.00 cm ³		
Jy	000.00 cm ⁴ Wy 000.00 cm ³		

XX70.705			Tavola
Profilo battuta cassonetto			
Peso	kg/ml. 0.155		
Jx	000.00 cm ⁴ Wx 000.00 cm ³		
Jy	000.00 cm ⁴ Wy 000.00 cm ³		

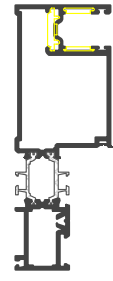
CX70.706			Tavola
Mezza spalla monoblocco			
Peso	kg/ml. 2.120		
Jx	165.80 cm ⁴ Wx 22.14 cm ³		
Jy	18.80 cm ⁴ Wy 6.56 cm ³		

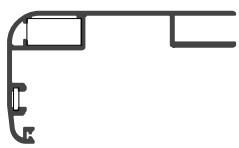
XX70.801			Tavola
Imbotte da mm.120			
Peso	kg/ml. 1.317		
Jx	76.93 cm ⁴ Wx 9.91 cm ³		
Jy	20.54 cm ⁴ Wy 4.10 cm ³		

XX70.802

Prolunga da 90 mm. per imbotte

Peso kg/ml. **0.882**
Jx 000.00 cm⁴ **Wx** 000.00 cm³
Jy 000.00 cm⁴ **Wy** 000.00 cm³



Tavola

XX70.803

Prolunga da 50 mm. per imbotte

Peso kg/ml. **0.570**
Jx 000.00 cm⁴ **Wx** 000.00 cm³
Jy 000.00 cm⁴ **Wy** 000.00 cm³

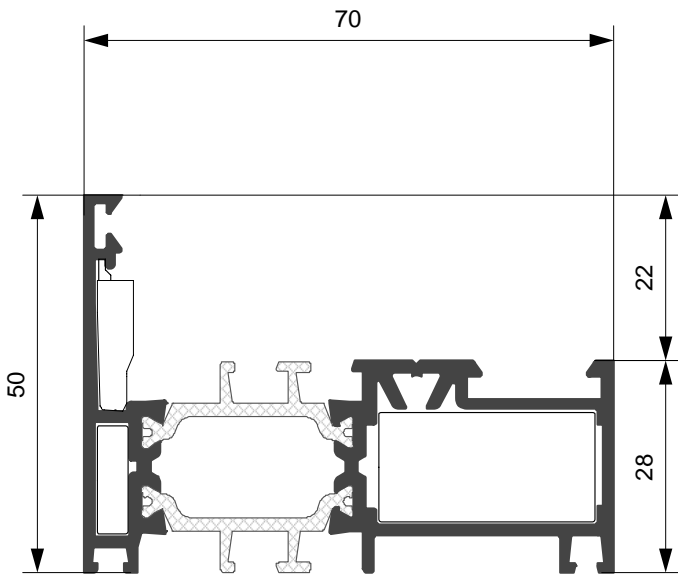
Tavola

CX70.101

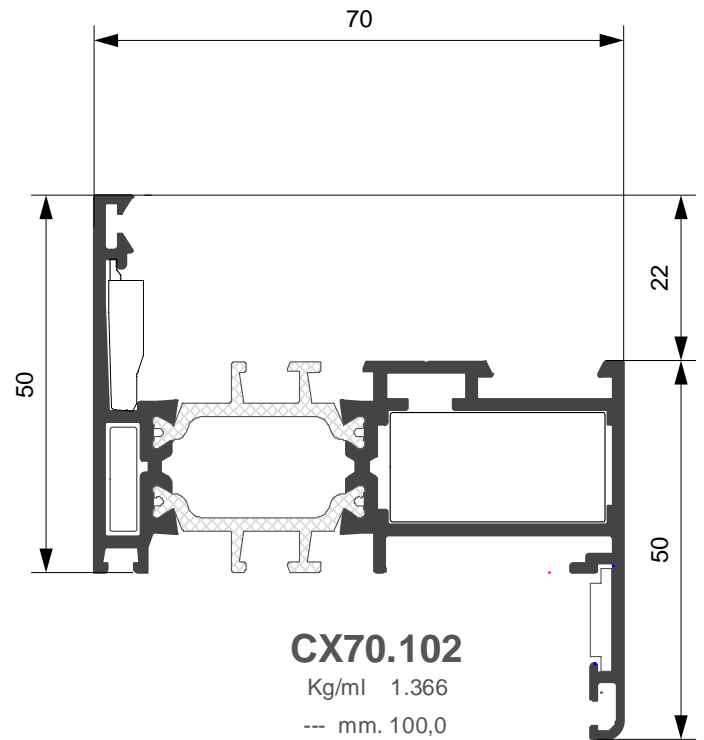
 Kg/ml 1.287
--- mm. 78,0

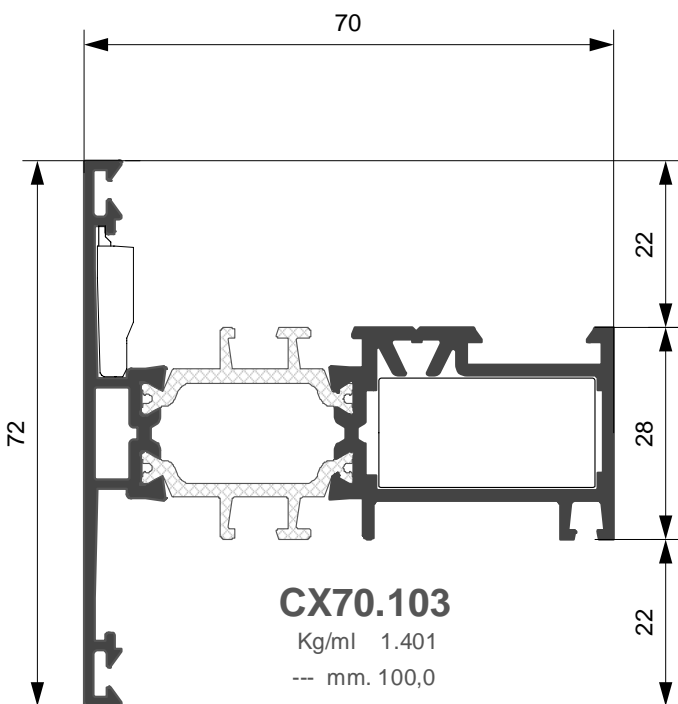
CX70.102

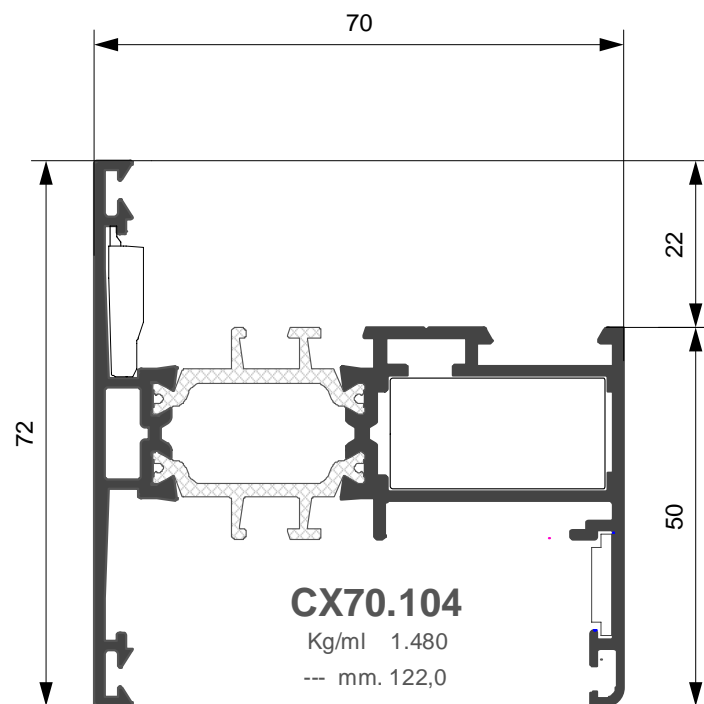
 Kg/ml 1.366
--- mm. 100,0

CX70.103

 Kg/ml 1.401
--- mm. 100,0

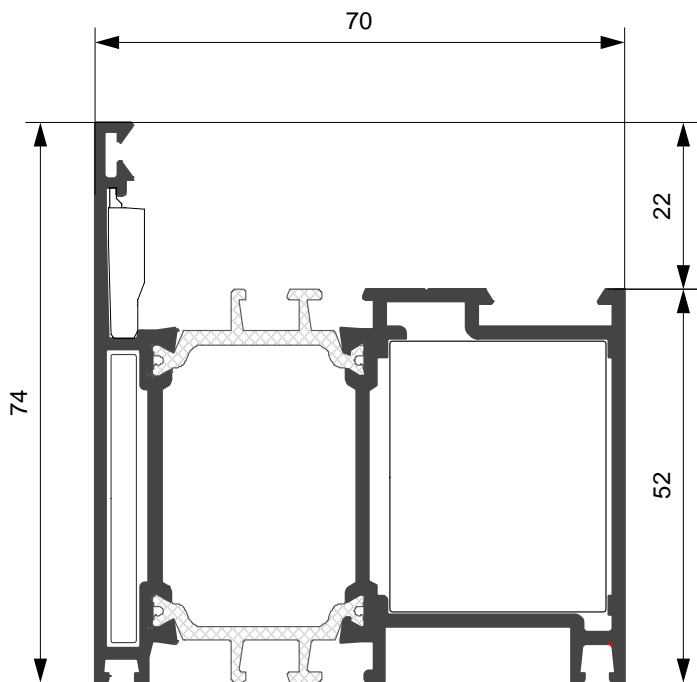
CX70.104

 Kg/ml 1.480
--- mm. 122,0

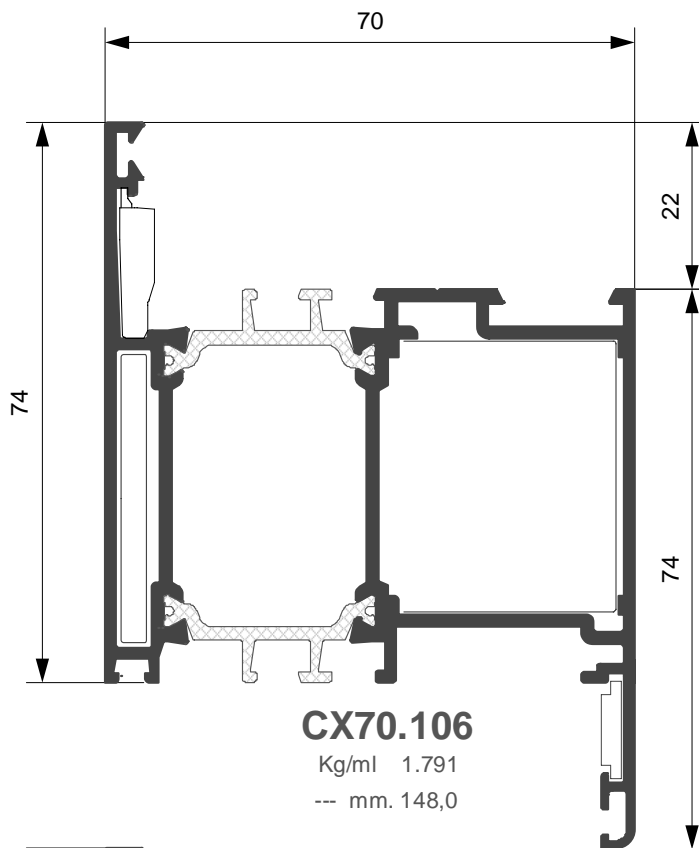
Profilato	Squadretta esterna		Squadretta interna			Squadretta allineamento	
	Cianfrinare	Spinare	Bottone	Cianfrinare	Spinare	Esterna	Interna
CX70.101	ARX.03.SQ	ARX.03.SQ + ARX.08.SQ	ACX.01.SQ	ACX.02.SQ	ACX.02.SQ + ARX.07.SQ	ARX.09.SQ	
CX70.102	ARX.03.SQ	ARX.03.SQ + ARX.08.SQ	ACX.01.SQ	ACX.02.SQ	ACX.02.SQ + ARX.07.SQ	ARX.09.SQ	ARX.10.SQ
CX70.103			ACX.01.SQ	ACX.02.SQ	ACX.02.SQ + ARX.07.SQ	ARX.09.SQ	
CX70.104			ACX.01.SQ	ACX.02.SQ	ACX.02.SQ + ARX.07.SQ	ARX.09.SQ	ARX.10.SQ

CX70.105

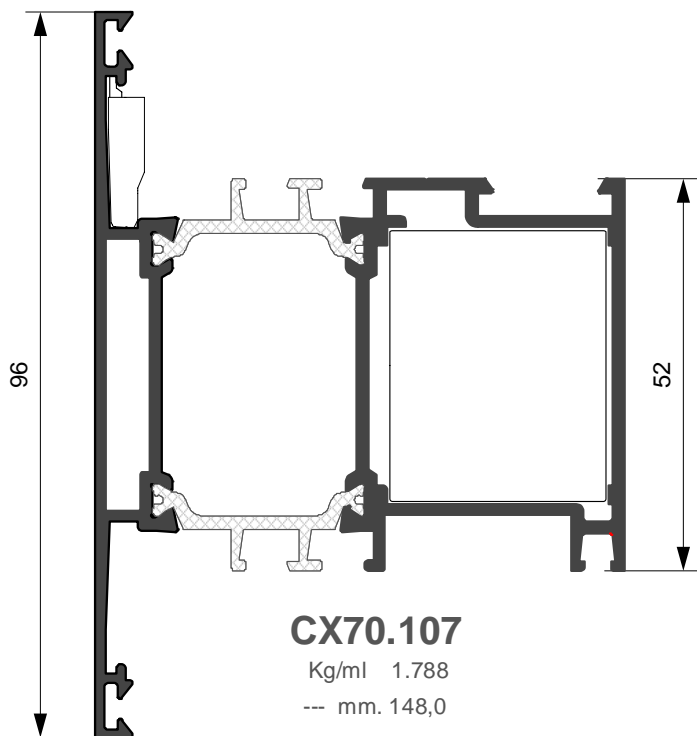
 Kg/ml 1.681
--- mm. 126,0

CX70.106

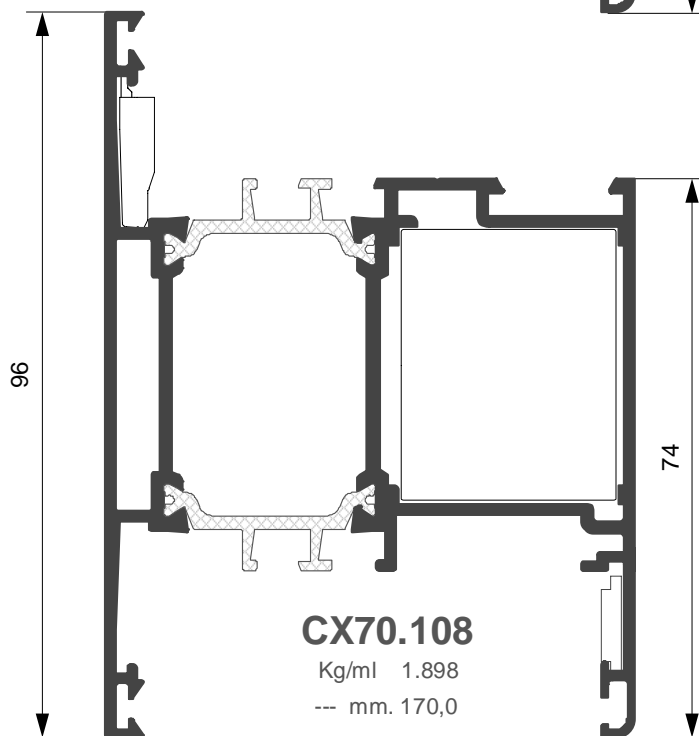
 Kg/ml 1.791
--- mm. 148,0

CX70.107

 Kg/ml 1.788
--- mm. 148,0

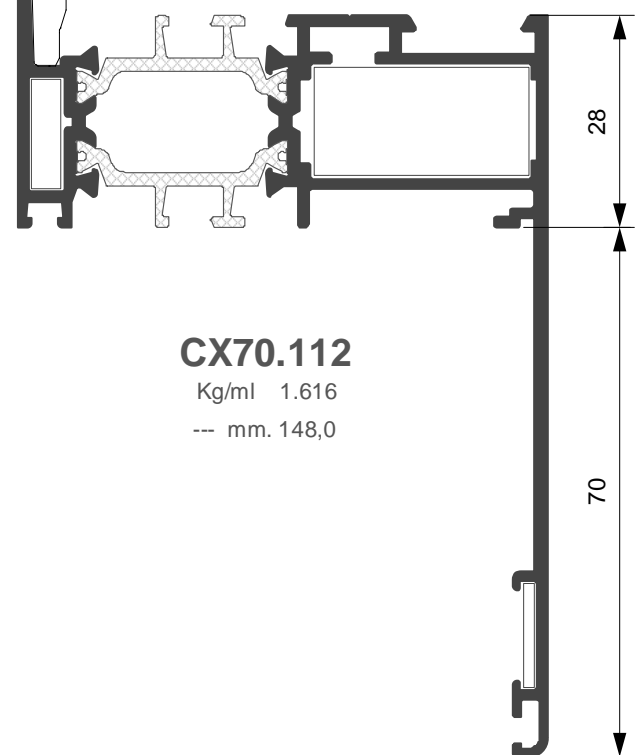
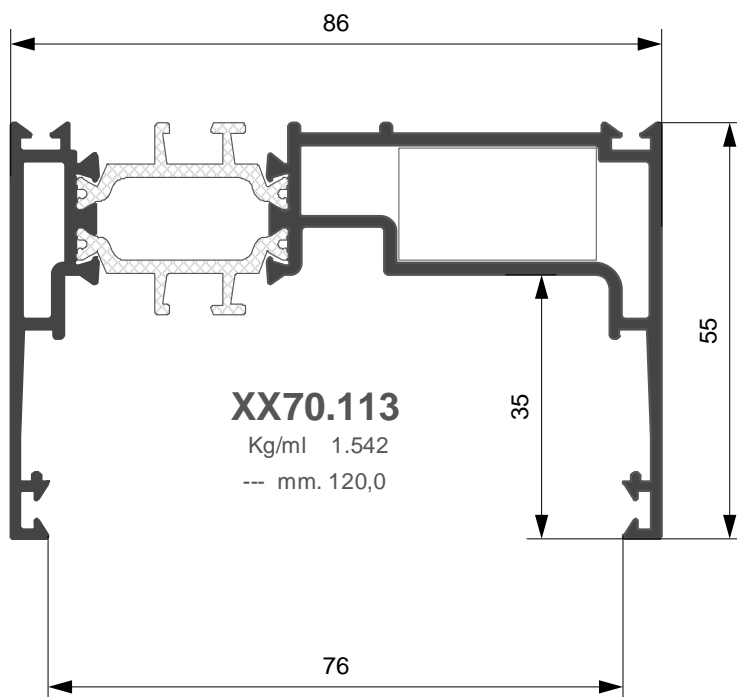
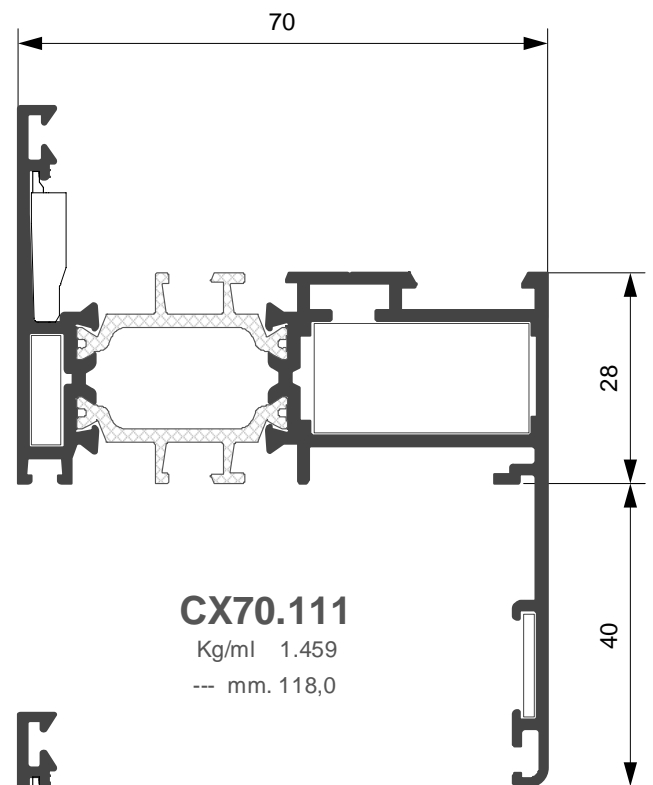
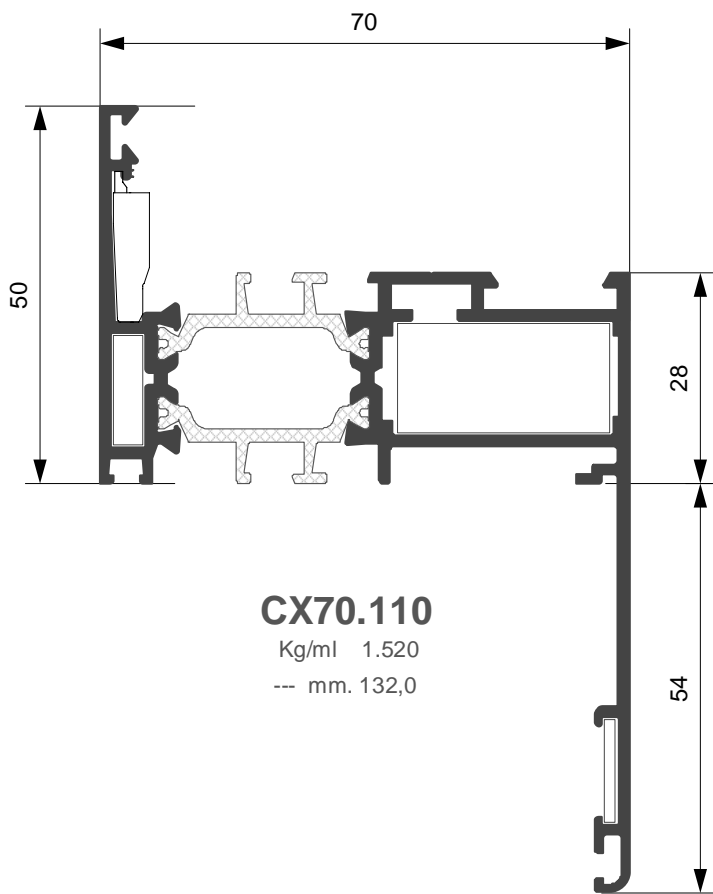
CX70.108

 Kg/ml 1.898
--- mm. 170,0

Profilato	Squadretta esterna		Squadretta interna			Squadretta allineamento	
	Cianfrinare	Spinare	Bottone	Cianfrinare	Spinare	Esterna	Interna
CX70.105	ARX.06.SQ	ARX.06.SQ + ARX.08.SQ	ACX.04.SQ			ARX.09.SQ	
CX70.106	ARX.06.SQ	ARX.06.SQ + ARX.08.SQ	ACX.04.SQ			ARX.09.SQ	ARX.10.SQ
CX70.107			ACX.04.SQ			ARX.09.SQ	
CX70.108			ACX.04.SQ			ARX.09.SQ	ARX.10.SQ

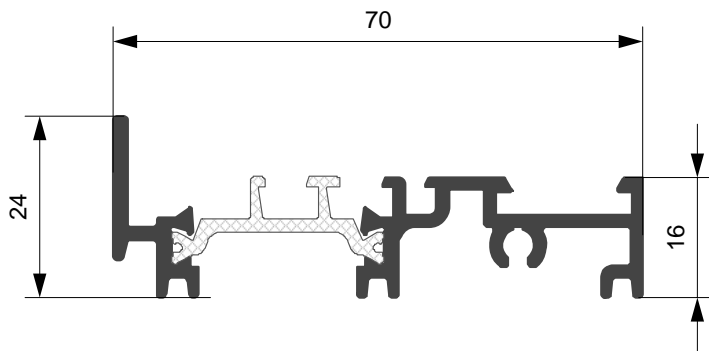

Profilato	Squadretta esterna		Squadretta interna			Squadretta allineamento	
	Cianfrinare	Spinare	Bottone	Cianfrinare	Spinare	Esterna	Interna
CX70.110	ARX.03.SQ	ARX.03.SQ + ARX.08.SQ	ACX.01.SQ	ACX.02.SQ	ACX.02.SQ + ARX.07.SQ	ARX.09.SQ	ARX.10.SQ
CX70.111	ARX.03.SQ	ARX.03.SQ + ARX.08.SQ	ACX.01.SQ	ACX.02.SQ	ACX.02.SQ + ARX.07.SQ	ARX.09.SQ	ARX.10.SQ
CX70.112	ARX.03.SQ	ARX.03.SQ + ARX.08.SQ	ACX.01.SQ	ACX.02.SQ	ACX.02.SQ + ARX.07.SQ	ARX.09.SQ	ARX.10.SQ
XX70.113			ACX.01.SQ	ACX.02.SQ	ACX.02.SQ + ARX.07.SQ	ARX.09.SQ	

CX70.409

Kg/ml 0.808

--- mm. 34,0

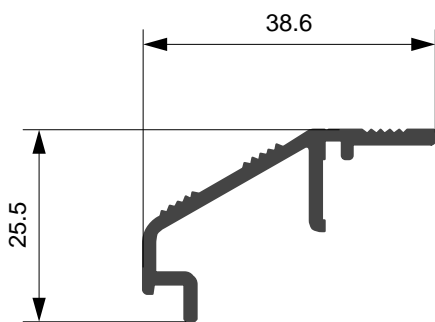
XX70.606

Kg/ml 0.322

--- mm. 50,0

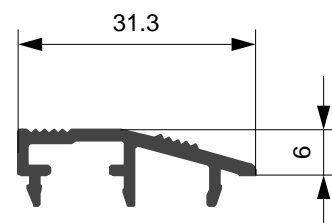

XX70.607

Kg/ml 0.224

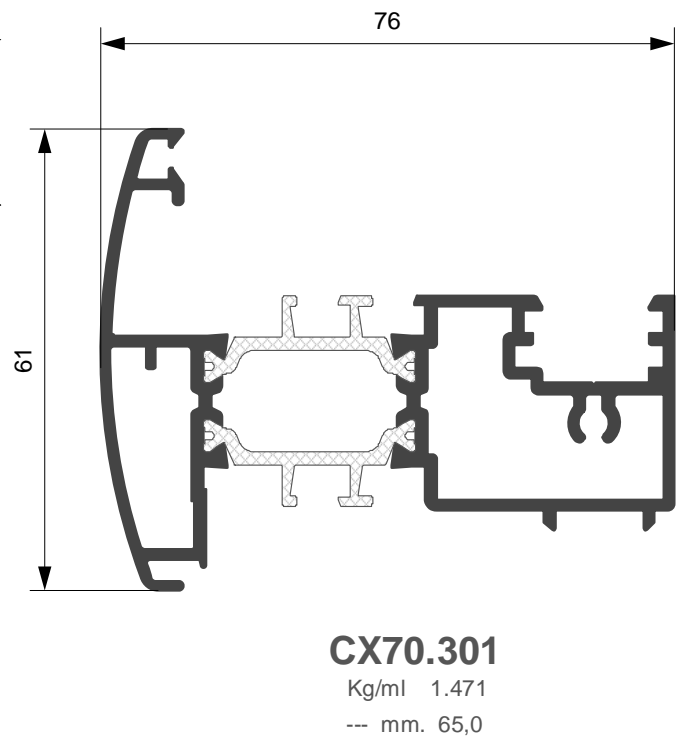
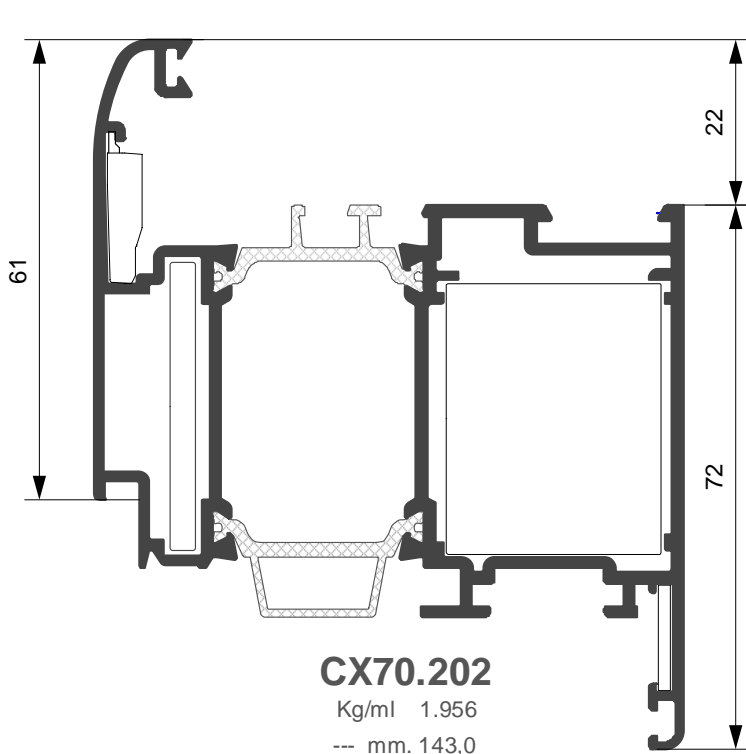
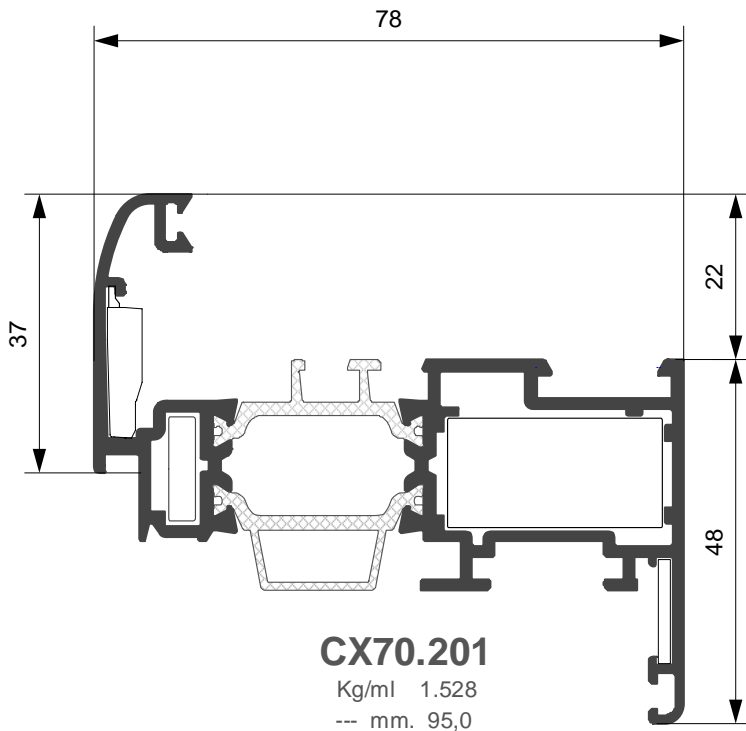
--- mm. 32,0

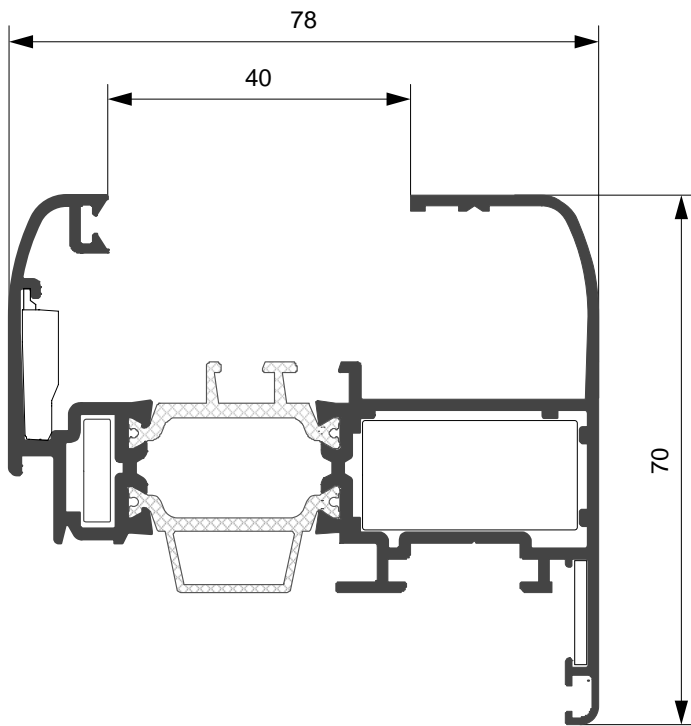

Profilato	Squadretta esterna		Squadretta interna			Squadretta allineamento	
	Cianfrinare	Spinare	Bottone	Cianfrinare	Spinare	Esterna	Interna
CX70.201	ARX.03.SQ	ARX.03.SQ + ARX.08.SQ	ACX.01.SQ	ACX.02.SQ	ACX.02.SQ + ARX.07.SQ	ARX.09.SQ	ARX.10.SQ
CX70.202	ARX.06.SQ	ARX.06.SQ + ARX.08.SQ	ACX.04.SQ			ARX.09.SQ	ARX.10.SQ

CX70.203

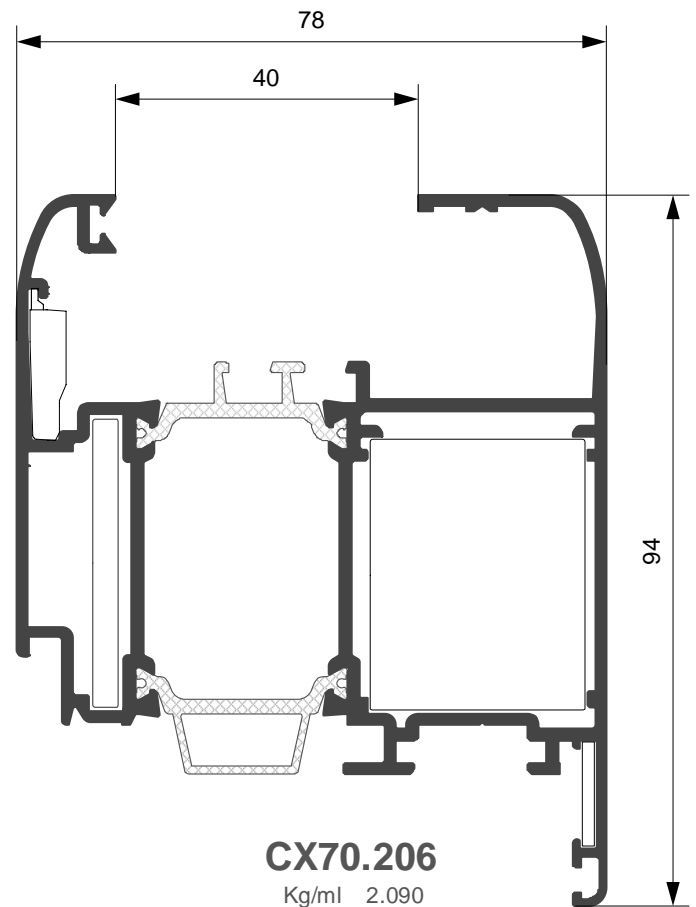
 Kg/ml 1.650
--- mm. 137,0

CX70.206

 Kg/ml 2.090
--- mm. 161,0

CX70.605

 Kg/ml 0,146
--- mm. 14,0

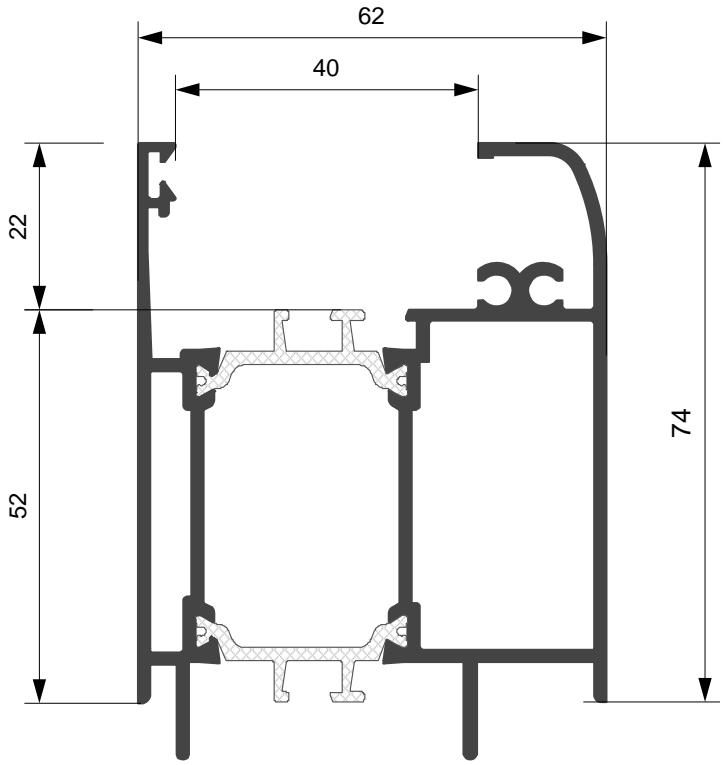
Profilato	Squadretta esterna		Squadretta interna			Squadretta allineamento	
	Cianfrinare	Spinare	Bottone	Cianfrinare	Spinare	Esterna	Interna
CX70.203		ARX.03.SQ + ARX.08.SQ	ACX.01.SQ		ACX.02.SQ + ARX.07.SQ	ARX.09.SQ	ARX.10.SQ
CX70.206		ARX.06.SQ + ARX.08.SQ	ACX.04.SQ			ARX.09.SQ	ARX.10.SQ



XX70.407
 Kg/ml 1.884
 --- mm. 162,0

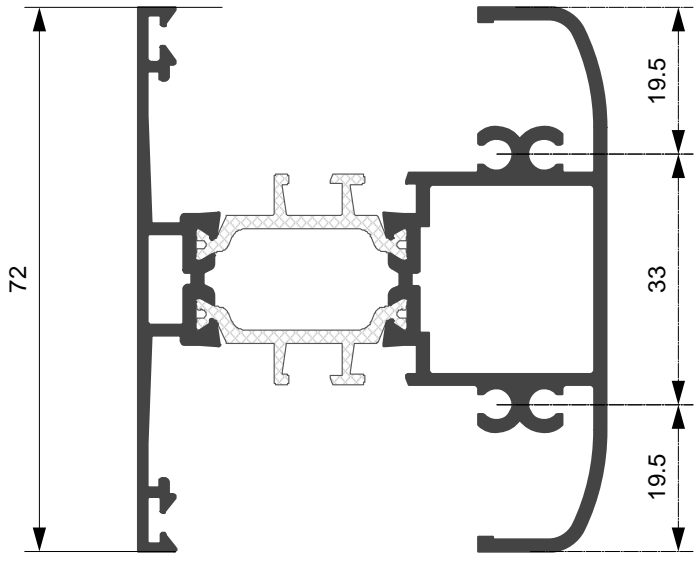

XX70.405
 Kg/ml 1.729
 --- mm. 170,0

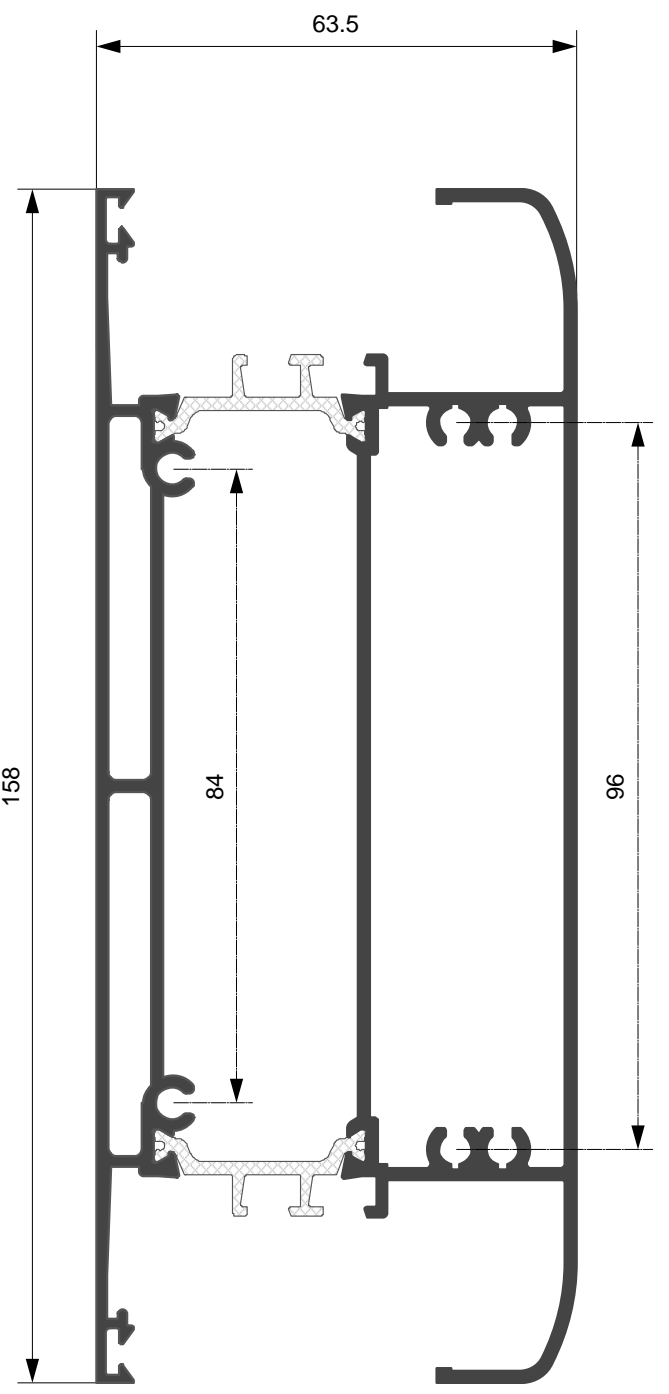

XX70.406
 Kg/ml 3.352
 --- mm. 332,0

Profilato	Squadretta esterna		Squadretta interna			Squadretta allineamento	
	Cianfrinare	Spinare	Bottone	Cianfrinare	Spinare	Esterna	Interna

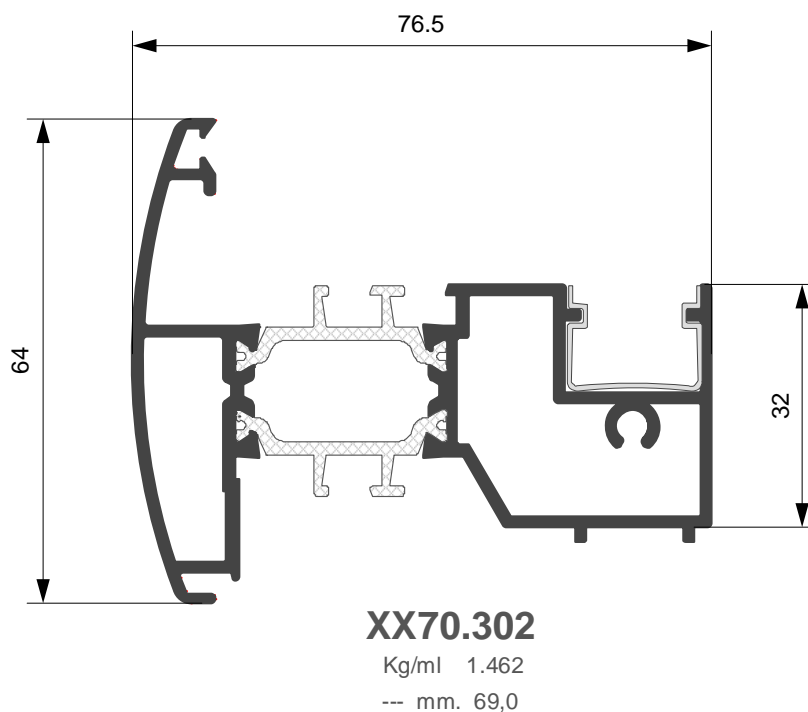
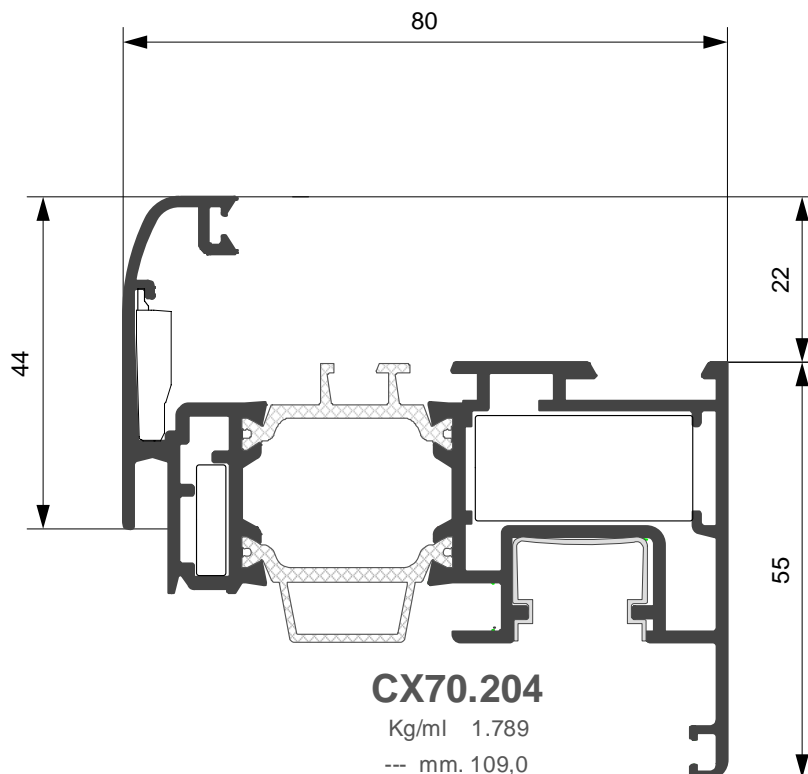
Ferramenta a nastro

XX70.601
 Kg/ml 0.269
 --- mm. 000,0

Profilato	Squadretta esterna		Squadretta interna			Squadretta allineamento	
	Cianfrinare	Spinare	Bottone	Cianfrinare	Spinare	Esterna	Interna
CX70.204	ARX.03.SQ	ARX.03.SQ + ARX.08.SQ	ACX.01.SQ	ACX.02.SQ	ACX.02.SQ + ARX.07.SQ	ARX.09.SQ	

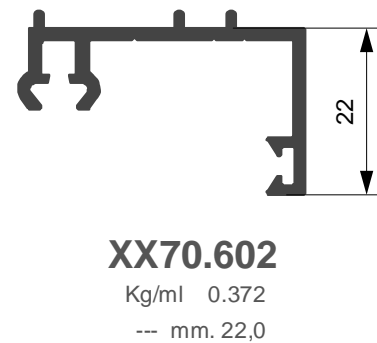
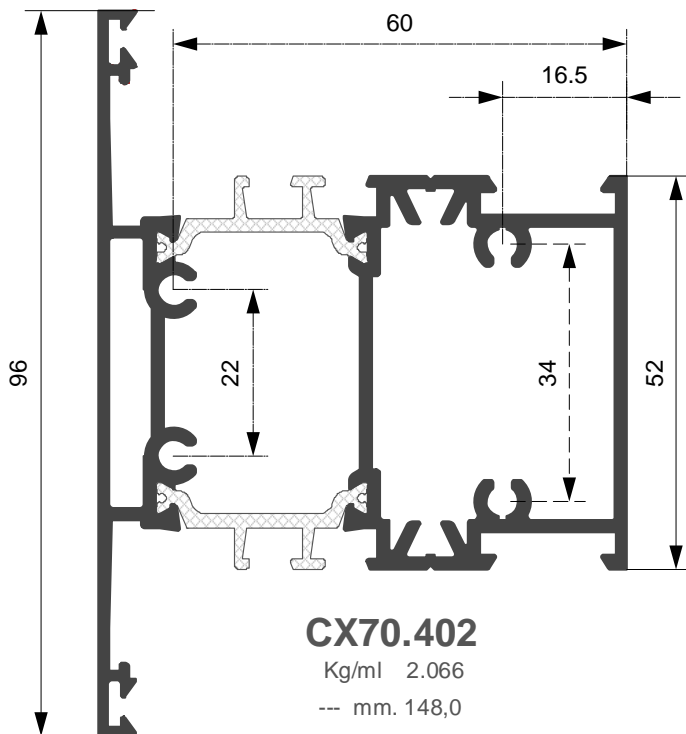
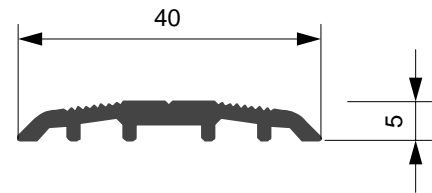
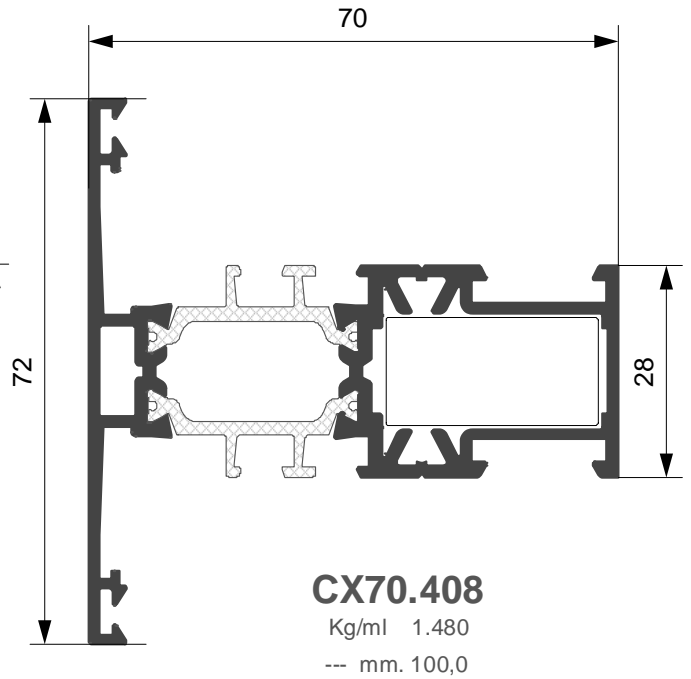
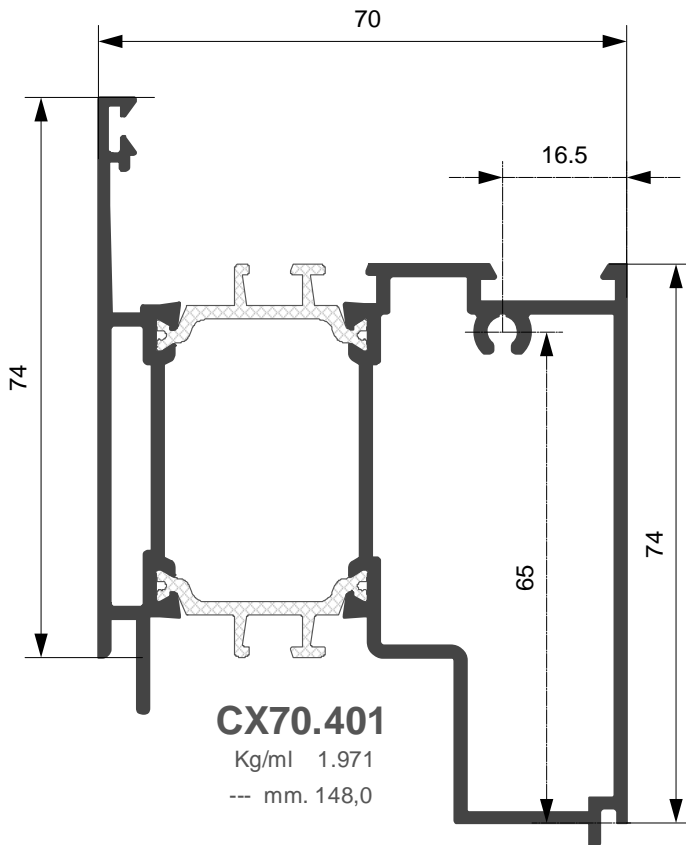

Profilato	Cavallotto	
	Esterno	Interno
CX70.408		ACX.12.SQ

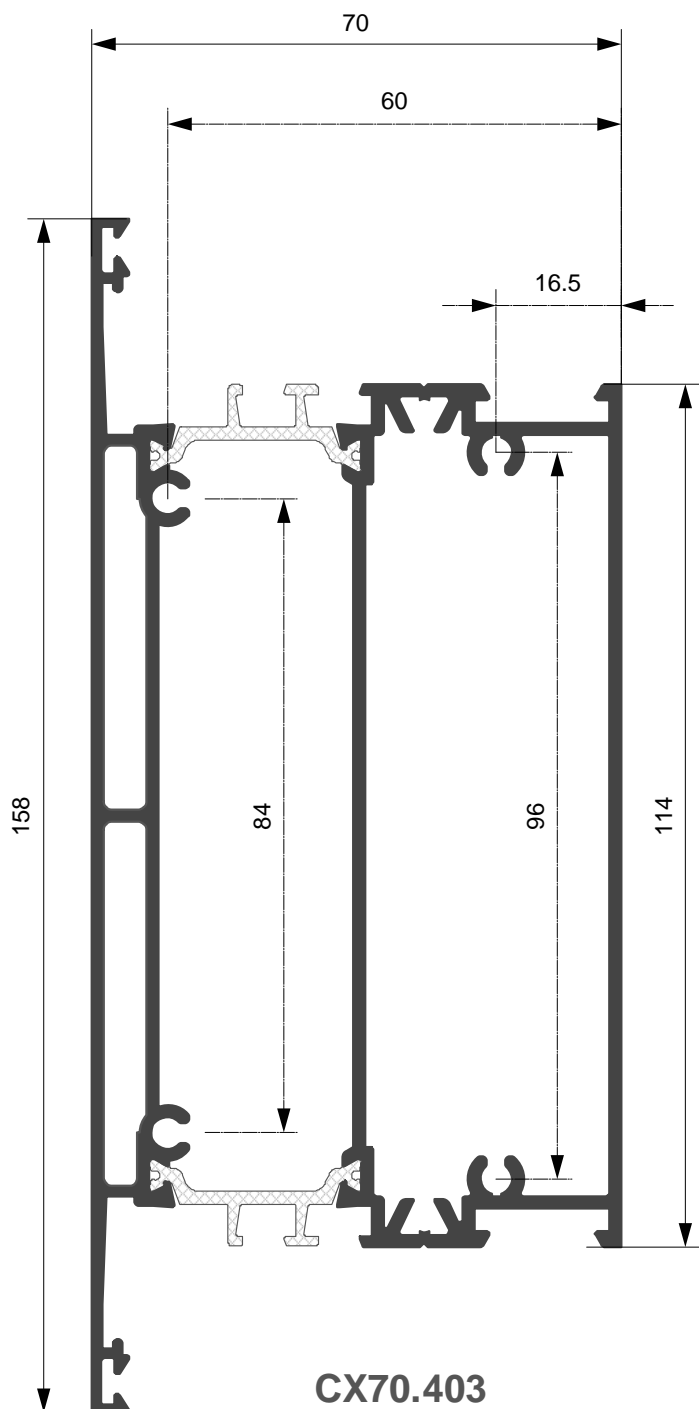
CX70.403

Kg/ml 3.174

--- mm. 254,0

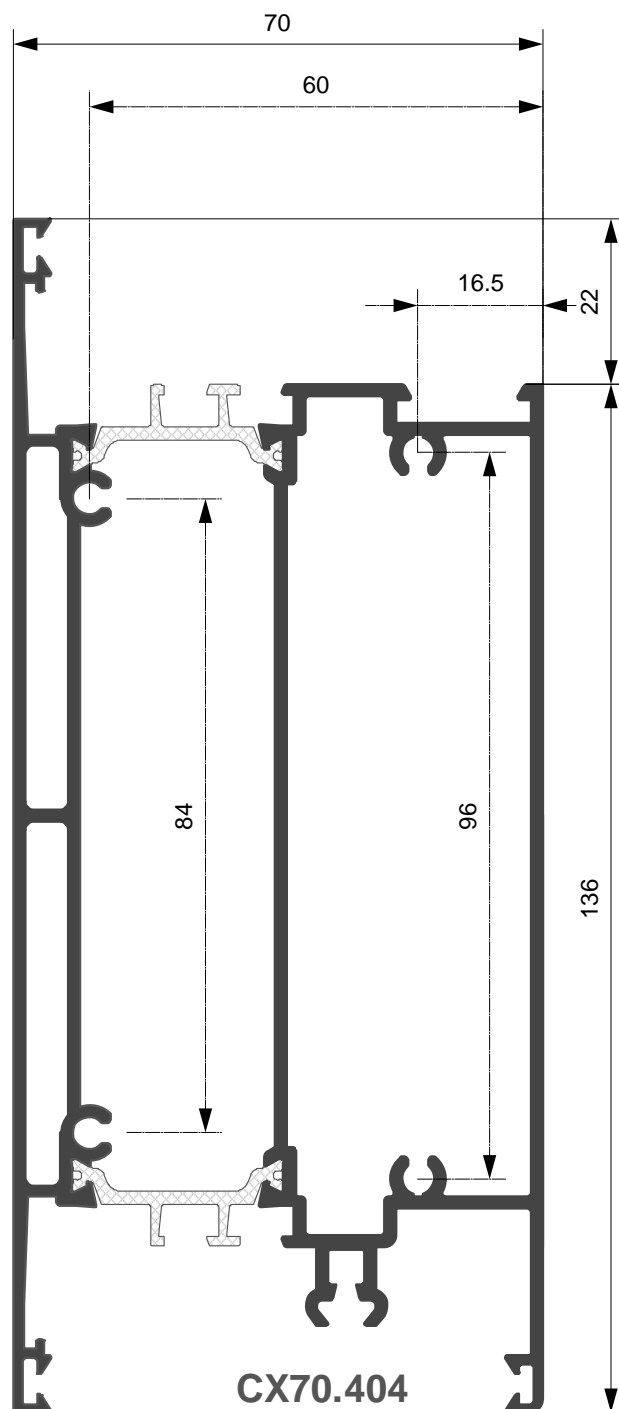
CX70.404

Kg/ml 3.284

--- mm. 276,0

Profilato	Squadretta esterna		Squadretta interna			Squadretta allineamento	
	Cianfrinare	Spinare	Bottone	Cianfrinare	Spinare	Esterna	Interna

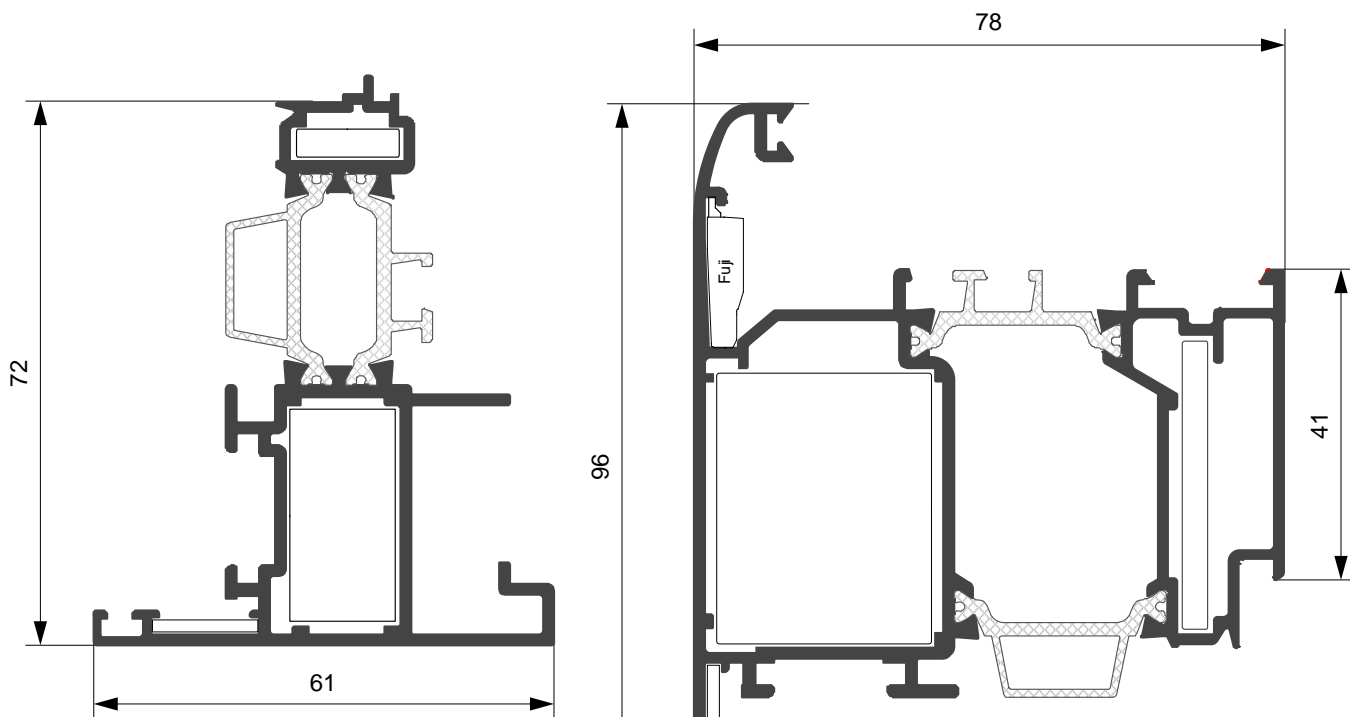
CX70.303

 Kg/ml 1.367
--- mm. 61,0

CX70.205

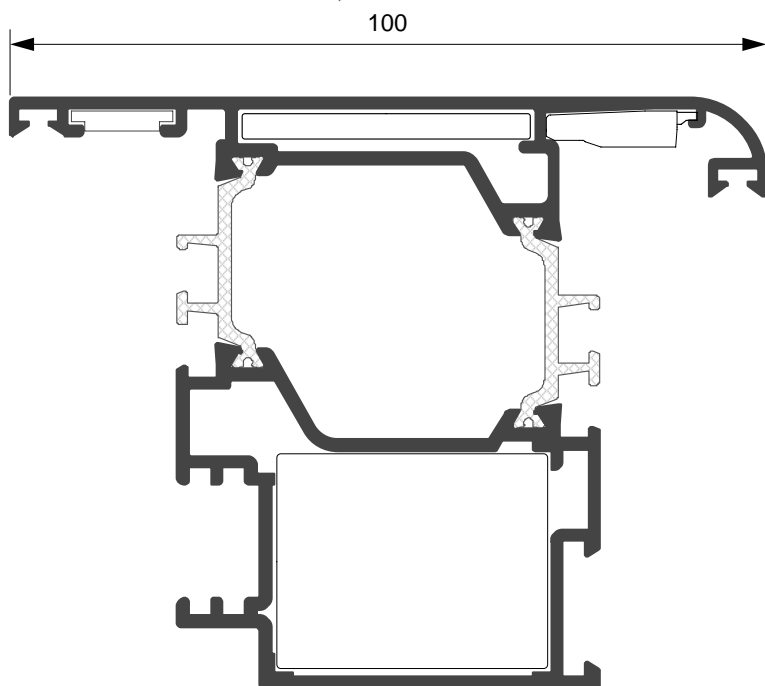
 Kg/ml 2.039
--- mm. 147,0

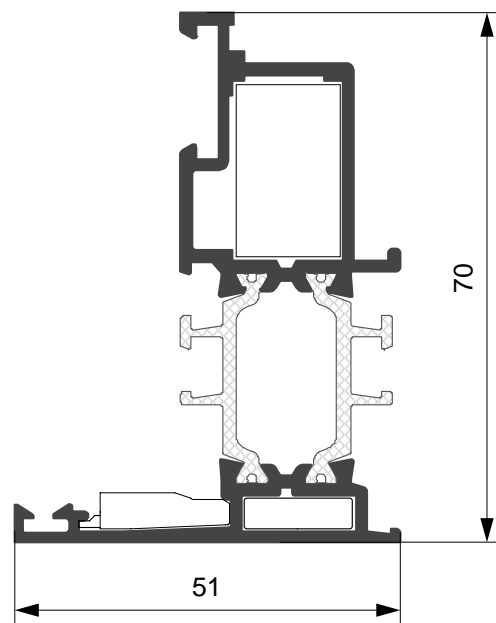
CX70.207

 Kg/ml 2.086
--- mm. 155,0

CX70.604

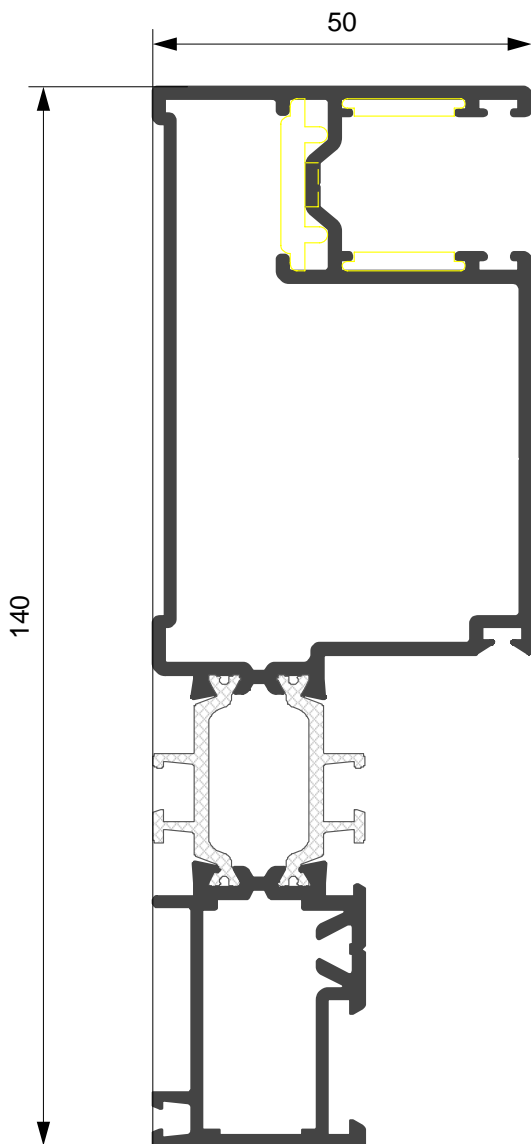
 Kg/ml 1.195
--- mm. 58,0

Profilato	Squadretta esterna		Squadretta interna			Squadretta allineamento	
	Cianfrinare	Spinare	Bottone	Cianfrinare	Spinare	Esterna	Interna
CX70.303	ARX.03.SQ	ARX.03.SQ + ARX.08.SQ	ACX.01.SQ	ACX.02.SQ	ACX.02.SQ + ARX.07.SQ		ARX.10.SQ
CX70.205	ARX.06.SQ	ARX.06.SQ + ARX.08.SQ	ACX.04.SQ			ARX.09.SQ	ARX.10.SQ
CX70.207	ARX.06.SQ		ACX.04.SQ			ARX.09.SQ	ARX.10.SQ

CX70.706

Kg/ml 2.120

--- mm. 85,0

XX70.705

Kg/ml 0.155

--- mm. 000,0

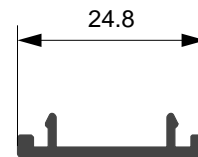
XX70.704

Kg/ml 0.135

--- mm. 25,0

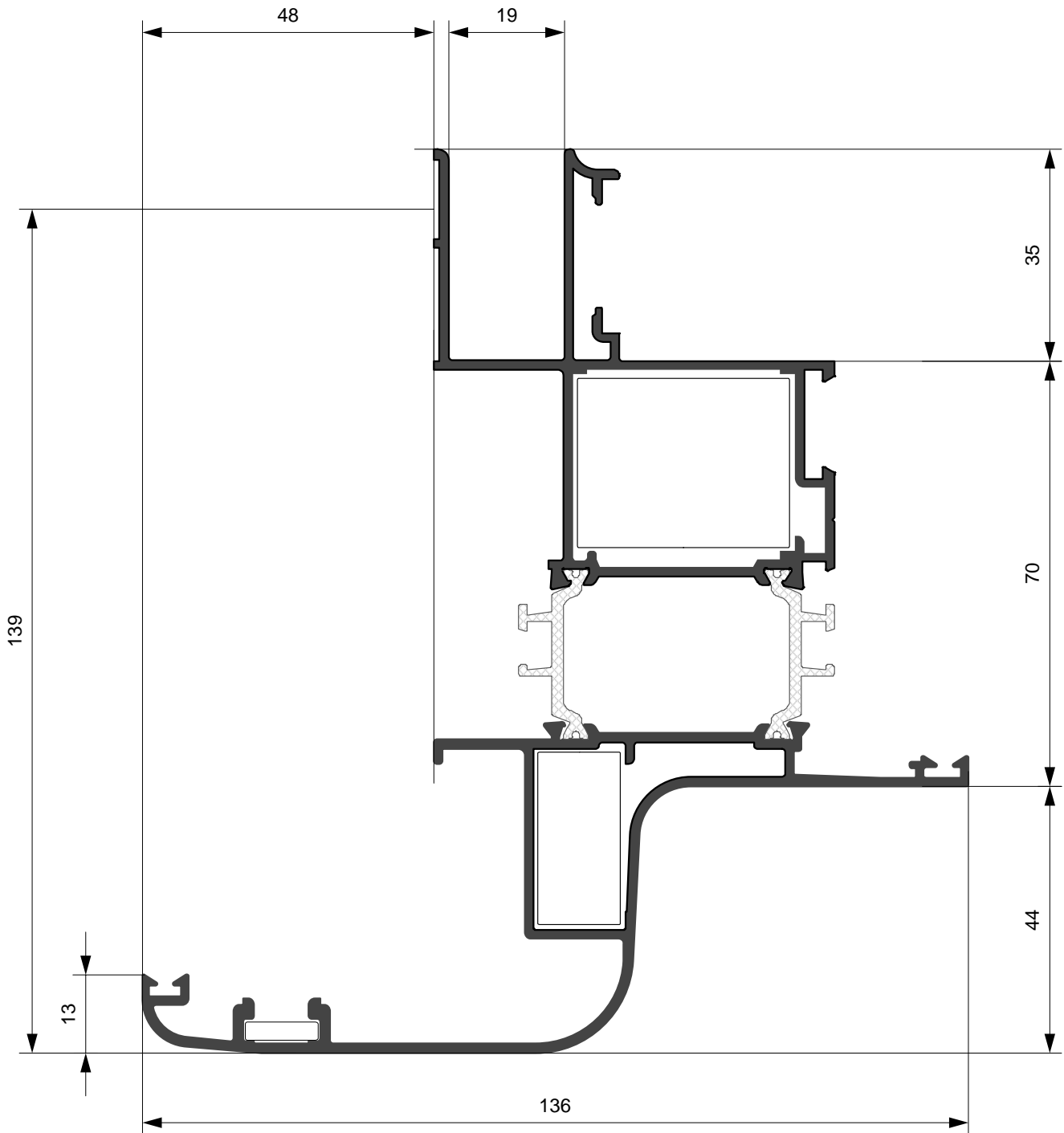
CX70.109

Kg/ml 2.883

--- mm. 242,0

Profilato	Squadretta esterna		Squadretta interna			Squadretta allineamento	
	Bottone	Spinare	Bottone	Cianfrinare	Spinare	Esterna	Interna
CX70.109	ACX.01.SQ	ACX.02.SQ + ARX.08.SQ	ACX.04.SQ			ARX.09.SQ	ARX.11.SQ

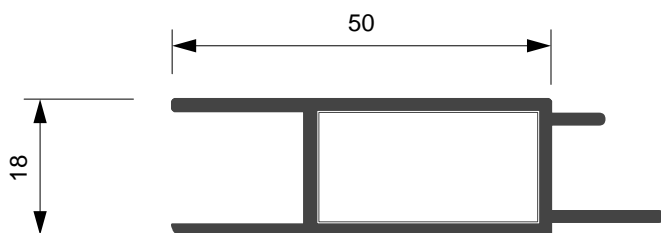
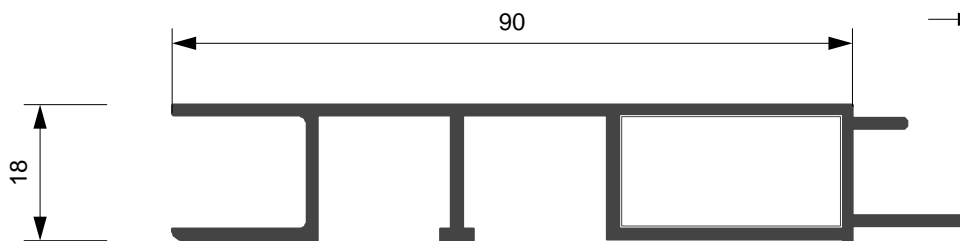
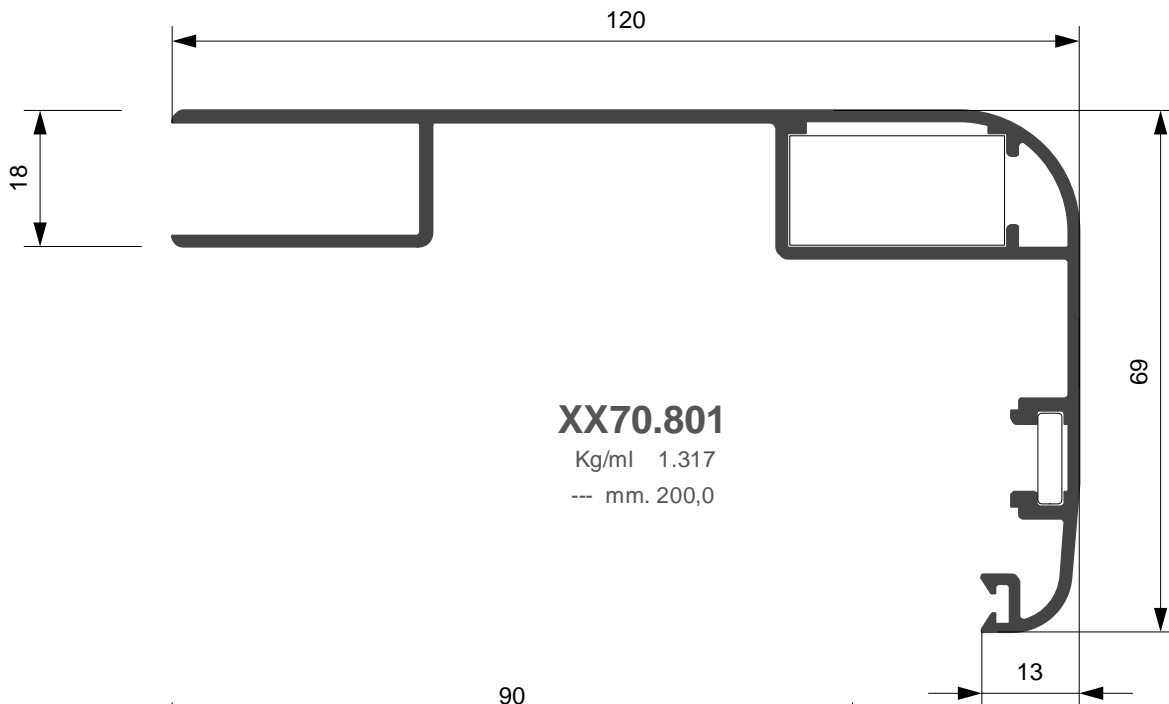

Profilato	Squadretta esterna		Squadretta interna			Squadretta allineamento	
	Bottone	Spinare	Bottone	Cianfrinare	Spinare	Esterna	Interna
XX70.801			ACX.01.SQ	ACX.02.SQ	ACX.02.SQ + ARX.07.SQ		ARX.11.SQ
XX70.802			ACX.01.SQ	ACX.02.SQ	ACX.02.SQ + ARX.07.SQ		
XX70.803			ACX.01.SQ	ACX.02.SQ	ACX.02.SQ + ARX.07.SQ		

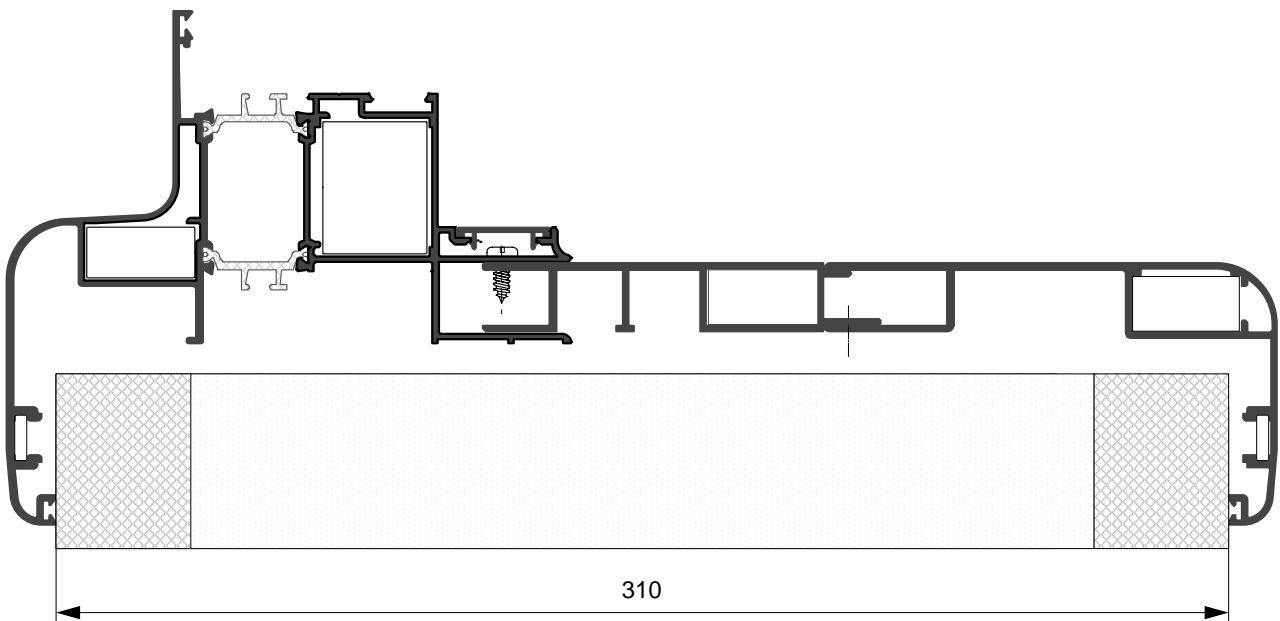
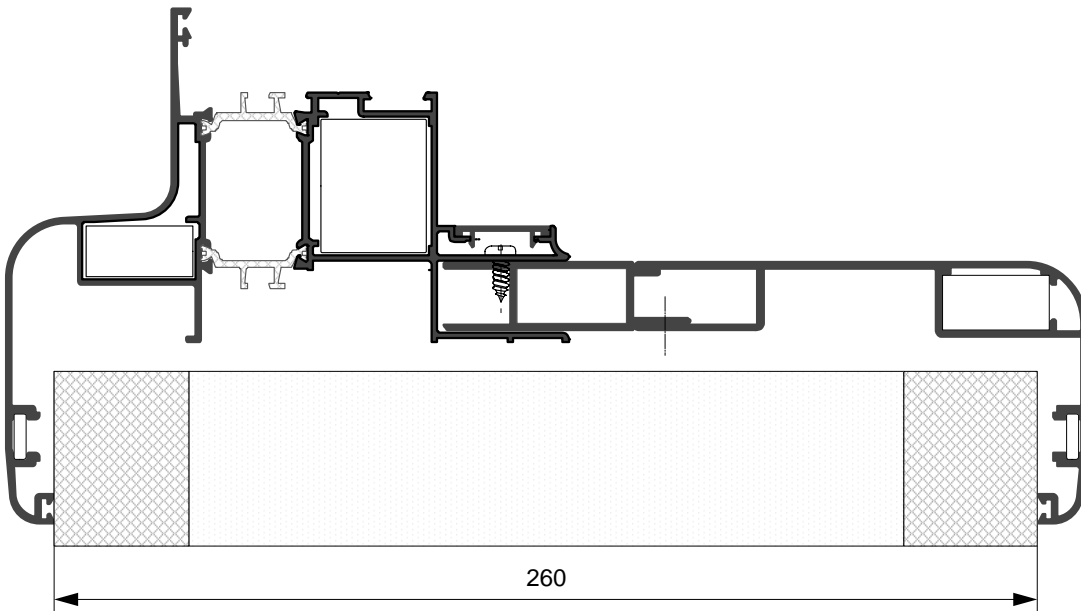
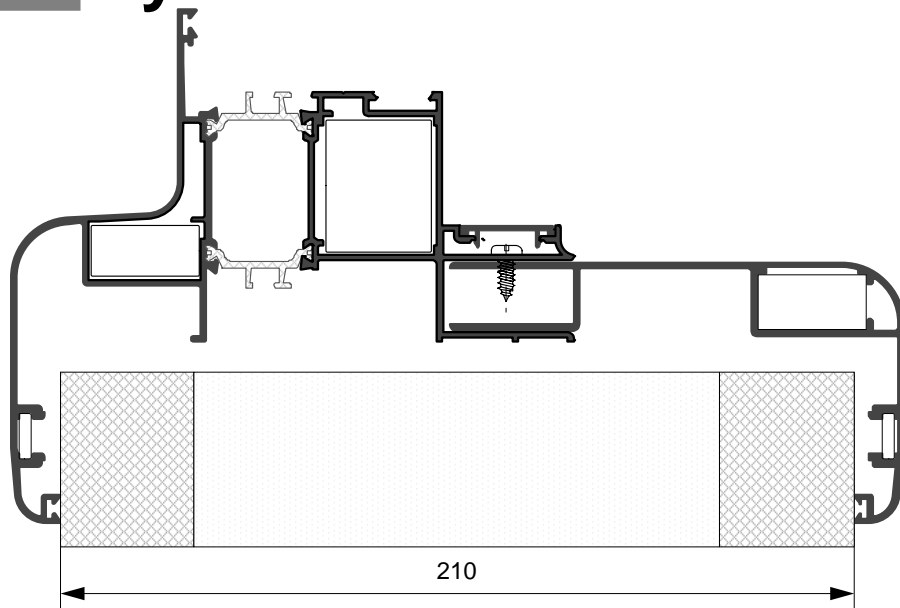

CX70.521

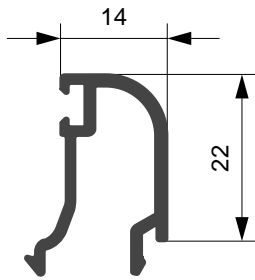
 Kg/ml 0.266
 --- mm. 36,0

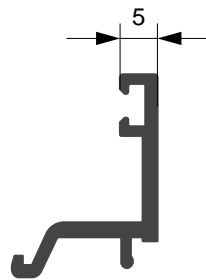
CX70.533

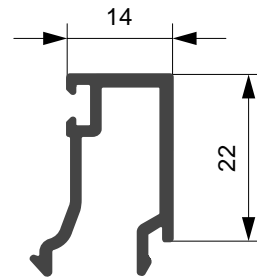
 Kg/ml 0.252
 --- mm. 27,0

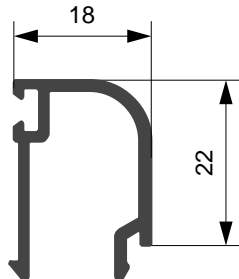
CX70.526

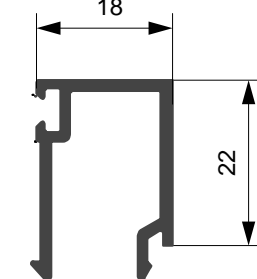
 Kg/ml 0.279
 --- mm. 36,0

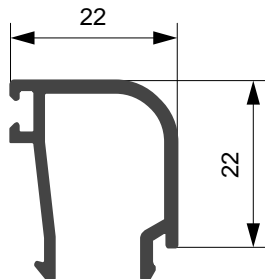
CX70.522

 Kg/ml 0.277
 --- mm. 40,0

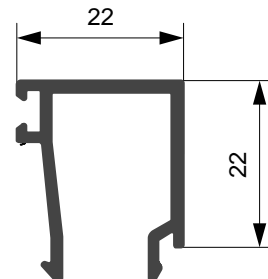
CX70.527

 Kg/ml 0.290
 --- mm. 40,0

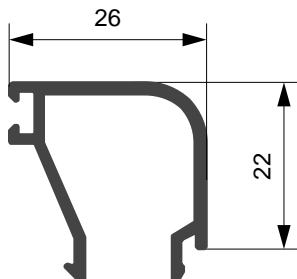
CX70.523

 Kg/ml 0.294
 --- mm. 44,0

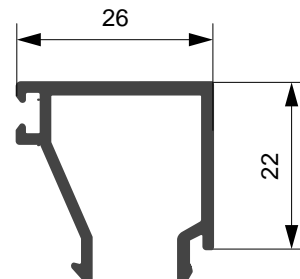
CX70.528

 Kg/ml 0.307
 --- mm. 44,0

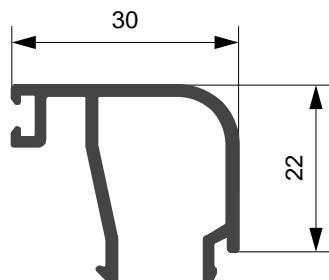
CX70.524

 Kg/ml 0.314
 --- mm. 48,0

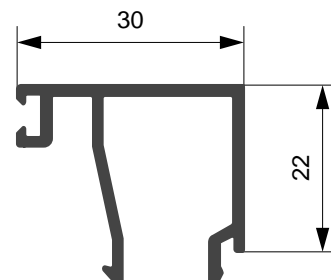
CX70.529



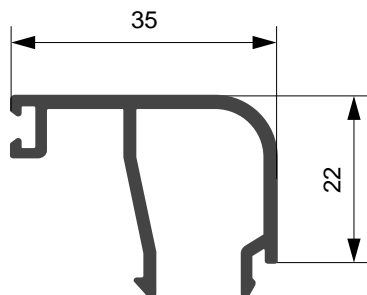

 Kg/ml 0.327
 --- mm. 48,0

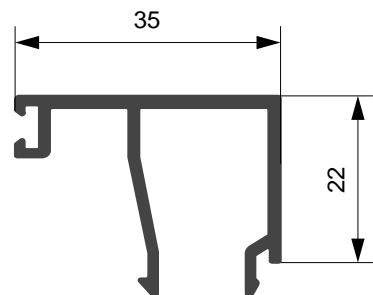
CX70.525

 Kg/ml 0.0350
 --- mm. 52,0

CX70.530

 Kg/ml 0.362
 --- mm. 52,0

CX70.531

 Kg/ml 0.370
 --- mm. 57,0

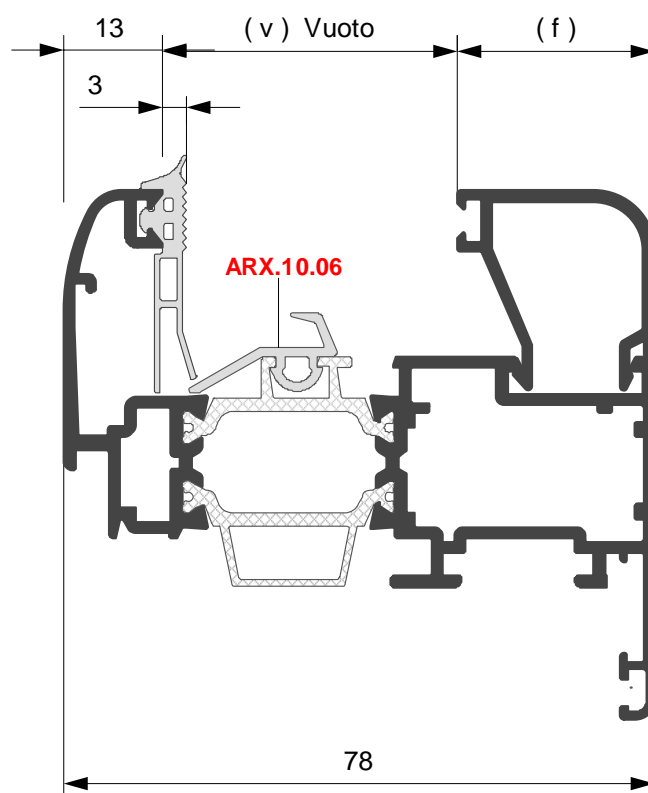
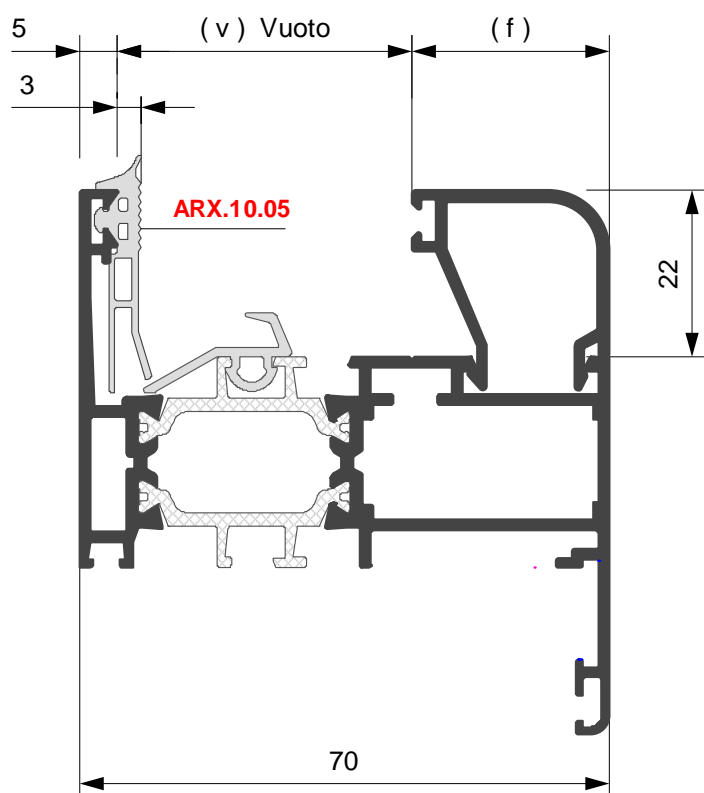
CX70.532

 Kg/ml 0.383
 --- mm. 57,0

Aletta (a) mm.	Vuoto (v) mm.	Dimensione fermavetro (f) mm.	Codice Fermavetro D = dritto T = tondo	Guarnizione esterna mm.	Guarnizioni interne vetro							
					ARX.10.15 		ARX.10.14 		ARX.10.13 		ARX.10.12 	
					mm.10	mm.9	mm.8	mm.7	mm.6	mm.5	mm.4	mm.3
Vetrazione (spessore vetro in mm.)												
5	30	35	D CX70.532 T CX70.531	3	17	18	19	20	21	22	23	24
5	35	30	D CX70.530 T CX70.525	3	22	23	24	25	26	27	28	29
5	39	26	D CX70.529 T CX70.524	3	26	27	28	29	30	31	32	33
5	43	22	D CX70.528 T CX70.523	3	30	31	32	33	34	35	36	37
5	46	18	D CX70.527 T CX70.522	3	34	35	36	37	38	39	40	41
5	51	14	D CX70.526 T CX70.521	3	38	39	40	41	42	43	44	45
5	60	5	D CX70.533	3	47	48	49	50	51	52	53	54



Squadrette

ACX.01.SQ	
Descrizione Squadretta a pulsante (28.5 mm x 14.5 mm)	
Materiale Zama	

ACX.02.SQ	
Descrizione Squadretta cianfrinare/spinare (28.5 mm x 14.5 mm)	
Materiale Zama	

ARX.03.SQ	
Descrizione Squadretta cianfrinare/spinare (4.3 mm x 14 mm)	
Materiale Zama	

ACX.04.SQ	
Descrizione Squadretta a pulsante (28.5 mm x 35.8 mm)	
Materiale Zama	

ACX.05.SQ	
Descrizione Squadretta angolo variabile (28.5 mm x 14.5 mm)	
Materiale Acciaio	

ARX.06.SQ	
Descrizione Squadretta cianfrinare/spinare (4.3 mm x 39.1 mm)	
Materiale Zama	

ARX.07.SQ	
Descrizione Spina per squadretta ACX.2.SQ	
Materiale Zama	

ARX.08.SQ	
Descrizione Spina per squadretta ACX.3.SQ e ACX.6.SQ	
Materiale Zama	

Squadrette

ARX.09.SQ	
Descrizione Squadretta allineamento est Fuji	
Materiale Zama	

ARX.10.SQ	
Descrizione Squadretta allineamento interna	
Materiale Nylon	

ARX.11.SQ	
Descrizione Squadretta allineamento interna	
Materiale Zama	

ACX.12.SQ	
Cavallotto (28.5 mm x 14.5 mm)	
Zama	

ARX.13.SQ	
Descrizione Squadretta a pulsante (23.5 mm x 14.5 mm)	
Materiale Zama	

Cerniere

ACX.02.01	
Descrizione Cerniera a montaggio rapido preassemblata a 2 ali	
Materiale Alluminio - Acciaio inox	

ACX.02.02	
Descrizione Cerniera a montaggio rapido preassemblata a 2 ali per 3° anta	
Materiale Alluminio - Acciaio inox	

ACX.02.03	
Descrizione Cerniera a montaggio rapido preassemblata a 3 ali	
Materiale Alluminio - Acciaio inox	

ACX.02.04	
Descrizione Cerniera a montaggio rapido preassemblata a 3 ali per 3° anta	
Materiale Alluminio - Acciaio inox	

ACX.02.05	
Descrizione Cerniera per vasistas apertura singola 30°	
Materiale Acciaio	

ACX.02.06	
Descrizione Cerniera per vasistas apertura doppia 30°/75°	
Materiale Acciaio	

ACX.02.07	
Descrizione Braccio lungo per vasistas (anta da mm. 600 a mm. 1600)	
Materiale Acciaio	

ACX.02.08	
Descrizione Braccio corto per vasistas (anta da mm. 280 a mm. 800)	
Materiale Acciaio	

Cerniere

ACX.02.09	
Descrizione Braccio telescopico per vasistas a scatto	
Materiale Acciaio	

ACX.02.10	
Descrizione Cerniera a compasso	
Materiale Acciaio	

ACX.02.11	
Descrizione Cerniera per porte con piastrina ad infilare	
Materiale Alluminio-Acciaio inox	

ACX.02.12	
Descrizione Cerniera per porte esterna a 2 ali interasse 60 mm.	
Materiale Alluminio-Acciaio inox	

ACX.02.13	
Descrizione Cerniera per porte esterna a 3 ali interasse 60 mm.	
Materiale Alluminio-Acciaio inox	

ACX.02.14	
Descrizione Cerniera per porte esterna a 2 ali interasse 79 mm.	
Materiale Alluminio-Acciaio inox	

ACX.02.15	
Descrizione Cerniera per porte esterna a 3 ali interasse 79 mm.	
Materiale Alluminio-Acciaio inox	

ACX.02.16	
Descrizione Spessore mm.8 per cerniere esterne per porte	
Materiale Alluminio-Acciaio inox	

Cerniere

ACX.02.17	
Descrizione Cerniera per scuretto	
Materiale Alluminio-Acciaio inox	

Chiusure

ACX.03.07	
Descrizione Cremonese con chiave Interasse 84 - 92 - 104	
Materiale Zama	

Chiusure

ACX.03.01	
Descrizione Cricchetto in alluminio fissaggio con piastrelle	
Materiale Zama - Acciaio	

ACX.03.08	
Descrizione Cremonese per Anta Ribalta	
Materiale Zama	

ACX.03.02	
Descrizione Maniglia a tavellino	
Materiale Zama	

ACX.03.09	
Descrizione Movimentazione Bidirezionale	
Materiale Zama	

ACX.03.03	
Descrizione Maniglia doppia	
Materiale Zama	

ACX.03.10	
Descrizione Movimentazione Unidirezionale per Anta Ribalta	
Materiale Zama	

ACX.03.04	
Descrizione Martellina	
Materiale Zama	

ACX.03.11	
Descrizione Catenacciolo a leva	
Materiale Zama	

ACX.03.05	
Descrizione Martellina con chiave	
Materiale Zama	

ACX.03.12	
Descrizione Terminale asta	
Materiale Zama	

ACX.03.06	
Descrizione Cremonese Interasse 84 - 92 - 104	
Materiale Zama	

ACX.03.13	
Descrizione Incontro asta singolo	
Materiale Zama	

ACX.03.14	
Descrizione Incontro asta doppio	
Materiale Zama	

Chiusure

ACX.03.15	
Descrizione Ferma anta	
Materiale Zama	

ACX.03.16	
Descrizione Perno di chiusura supplementare regolabile	
Materiale Zama	

ACX.03.17	
Descrizione Innesti cremonese	
Materiale Nylon	

ACX.03.18	
Descrizione Terminali astina	
Materiale Nylon	

ACX.03.19	
Descrizione Sostegno anta	
Materiale Nylon	

Scarichi acqua

ACX.05.01	
Descrizione Cappetta drenaggio acqua	
Materiale Nylon	

Attacchi muratura

ACX.06.01	
Descrizione Registro Universale	
Materiale Nylon	

ACX.06.02	
Descrizione Piastrina Registro Universale	
Materiale Zama	

ACX.06.03	
Descrizione Grano per registro	
Materiale Alluminio	

Tappi

ACX.04.01	
Descrizione Tappo riporto Giunto Aperto	
Materiale Dutral	

ACX.04.02	
Descrizione Tappo riporto Giunto Aperto Ferramenta perimetrale	
Materiale Dutral	

Accessori vetro

ACX.07.02	
Descrizione Angolo Universale fermavetro	
Materiale Zama	

Anta ribalta
ACX.08.01

Descrizione

**Anta Ribalta Kit BASE
senza cremonese con
anti falsa manovra sulla
cremonese**



Materiale

ACX.08.08

Descrizione

**A. R. Kit catenacci a leva
per anta affiancata**

Materiale

ACX.08.09

Descrizione

A. R. Cerniere a pettine

Materiale

ACX.08.02

Descrizione

Anta Ribalta Braccio Corto

Materiale

ACX.08.10

Descrizione

**A. R. Astina prelaborata
per anta affiancata**

Materiale

ACX.08.03

Descrizione

Anta Ribalta Braccio Medio

Materiale

ACX.08.04

Descrizione

Anta Ribalta Braccio Lungo

Materiale

ACX.08.05

Descrizione

A. R. Braccio Supplementare

Materiale

ACX.08.06

Descrizione

A. R. Rinvio Supplementare

Materiale

ACX.08.07

Descrizione

**A. R. Punto chiusura
supplementare**

Materiale

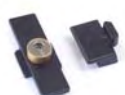
Attrezzature
ACX.09.01

Descrizione

Attrezzatura Pneumatica

ACX.09.02

Descrizione

KIT FRESE

Materiale



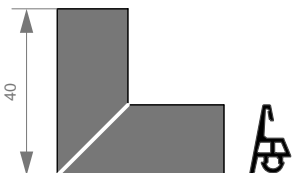

Guarnizioni

ACX.10.01	
Descrizione	
Guarnizione Centrale di Precamera	

ACX.10.02	
Descrizione	
Angolo per guarnizione centrale di Precamera art. ACX.10.01	

ACX.10.03	
Descrizione	
Guarnizione di battuta a scatto	

ACX.10.04	
Descrizione	
Guarnizione di battuta ad infilo	

ACX.10.05	
Descrizione	
Guarnizione vetro esterna per isolamento termico-acustico	

ACX.10.06	
Descrizione	
Guarnizione sotto vetro per isolamento termico-acustico	

ACX.10.07	
Descrizione	
Guarnizione di battuta esterna acustica esterna mm.1	

Guarnizioni

ACX.10.08	
Descrizione	
Guarnizione di battuta per ferramenta a nastro	

ACX.10.09	
Descrizione	
Canalina isolante per ferramenta a nastro	

ACX.10.10	
Descrizione	
Spazzola a pavimento	

ACX.10.11	
Descrizione	
Guarnizione supplementare di Precamera	

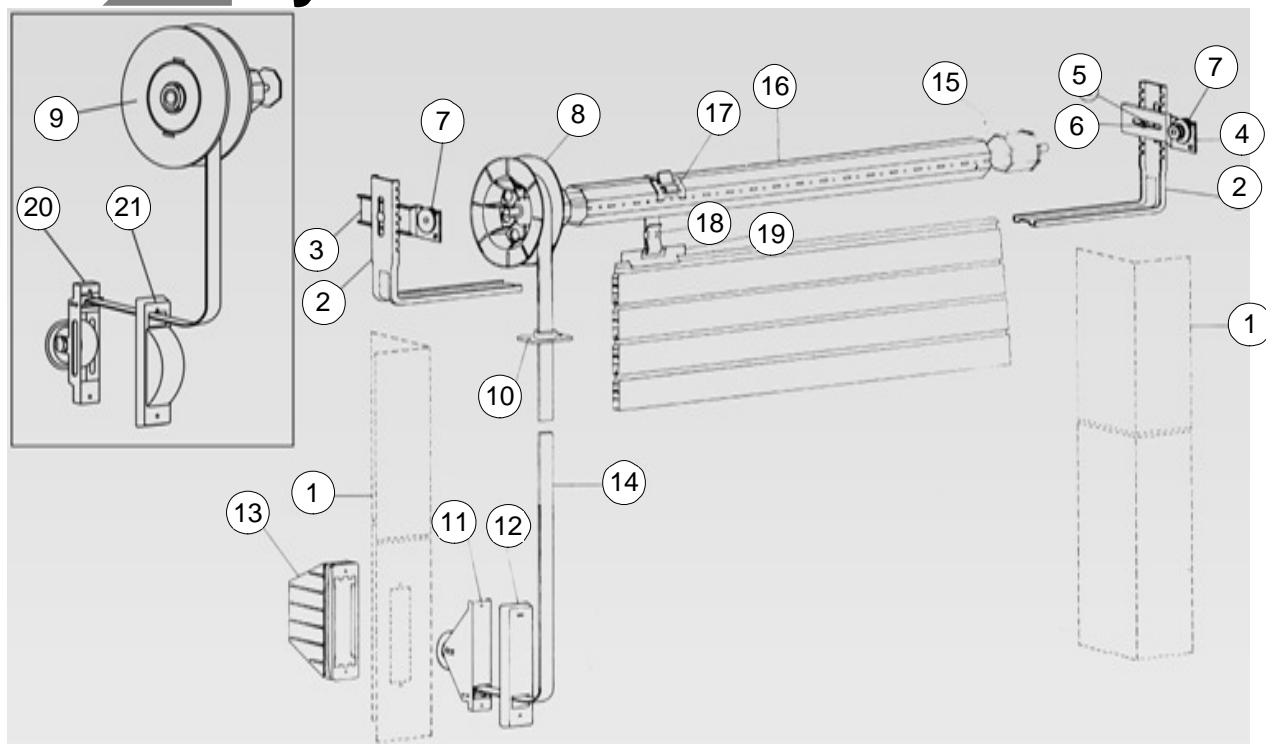
Monoblocco - Soluzione con puleggia

Codice	Descrizione	N° Pz.	Note	Rifer.
ARX.11.01	Supporto a squadra A = mm 46	2		2
ARX.11.02	Mensola per supporto (SIN)	1		3
ARX.11.03	Mensola per supporto (DX)	1		4
ARX.11.04	Vite 6 x 20 con dado	2		5 - 6
ARX.11.05	Boccola in nylon	2		7
ARX.11.06	Puleggia in plastica a minimo ingombro Ø 220	1	scegliere tipo	8
ARX.11.07	Guida cinghia trasversale in nylon	1	scegliere colore	10
ARX.11.08	Avvolgitore	1		11
ARX.11.09	Placca	1	scegliere tipo	12
ARX.11.10	Cassetta	1	scegliere tipo	13
ARX.11.11	Cintino	Mt.	scegliere tipo	14
ARX.11.12	Calotta in plastica	1		15
ARX.11.13	Rullo ottagonale	Mt.	scegliere tipo	16
ARX.11.14	Gancio per attacco cintino al rullo	2		17
ARX.11.15	Grappa fermacintino	2		18
ARX.11.16	Gancio per avvolgibili in plastica con asola	2		19

Monoblocco - Soluzione con puleggia

ARX.11.18	Riduttore portata 40 kg. R=1:2,6 Puleggia Ø 220	1		9
ARX.11.19	Avvolgitore	1		20
ARX.11.20	Placca	1	scegliere tipo	21

Vari

ARX.11.21	Invito tapparella in nylon su profilo in alluminio
ARX.11.22	Coppia tappi laterali cassetta in alluminio

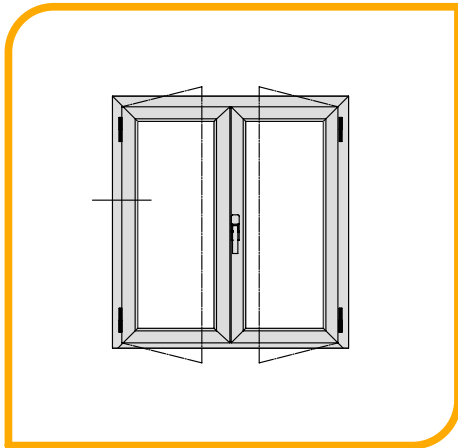

FINESTRA A 2 ANTE

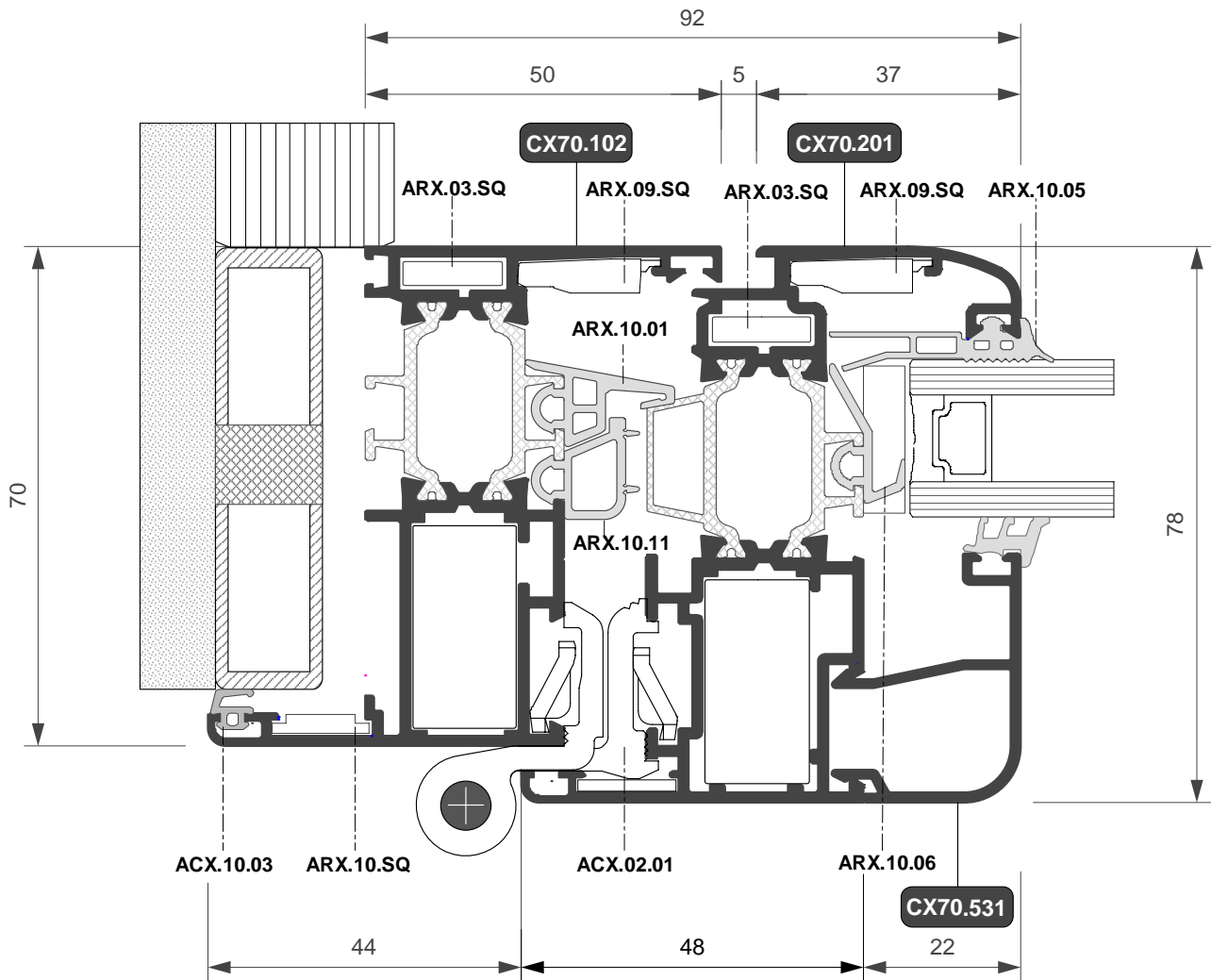

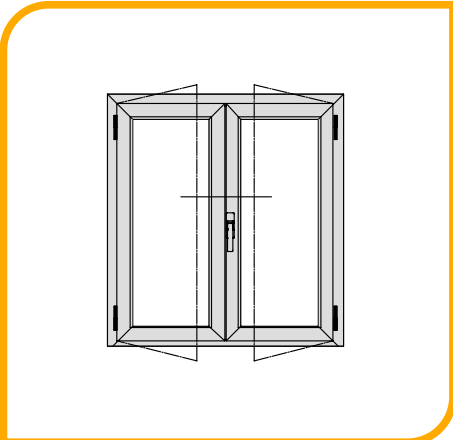

FINESTRA A 2 ANTE

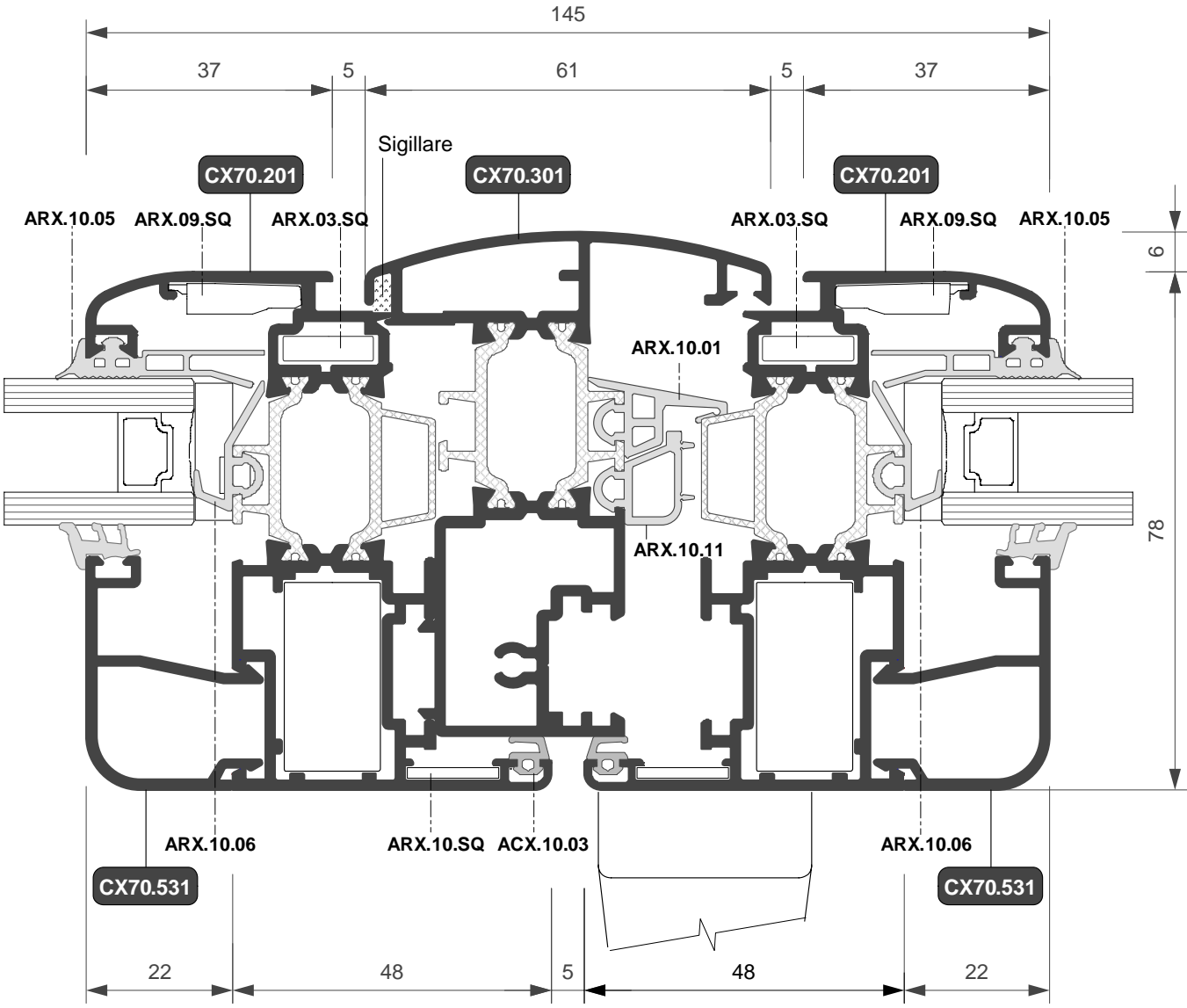

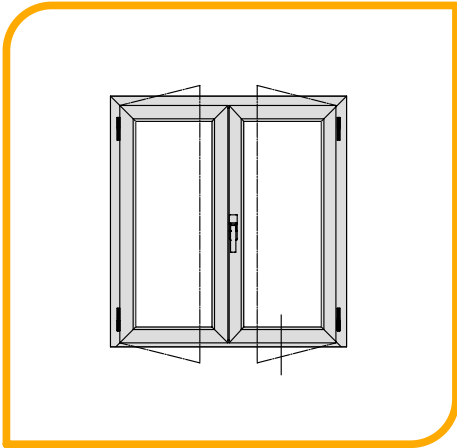

FINESTRA A 2 ANTE

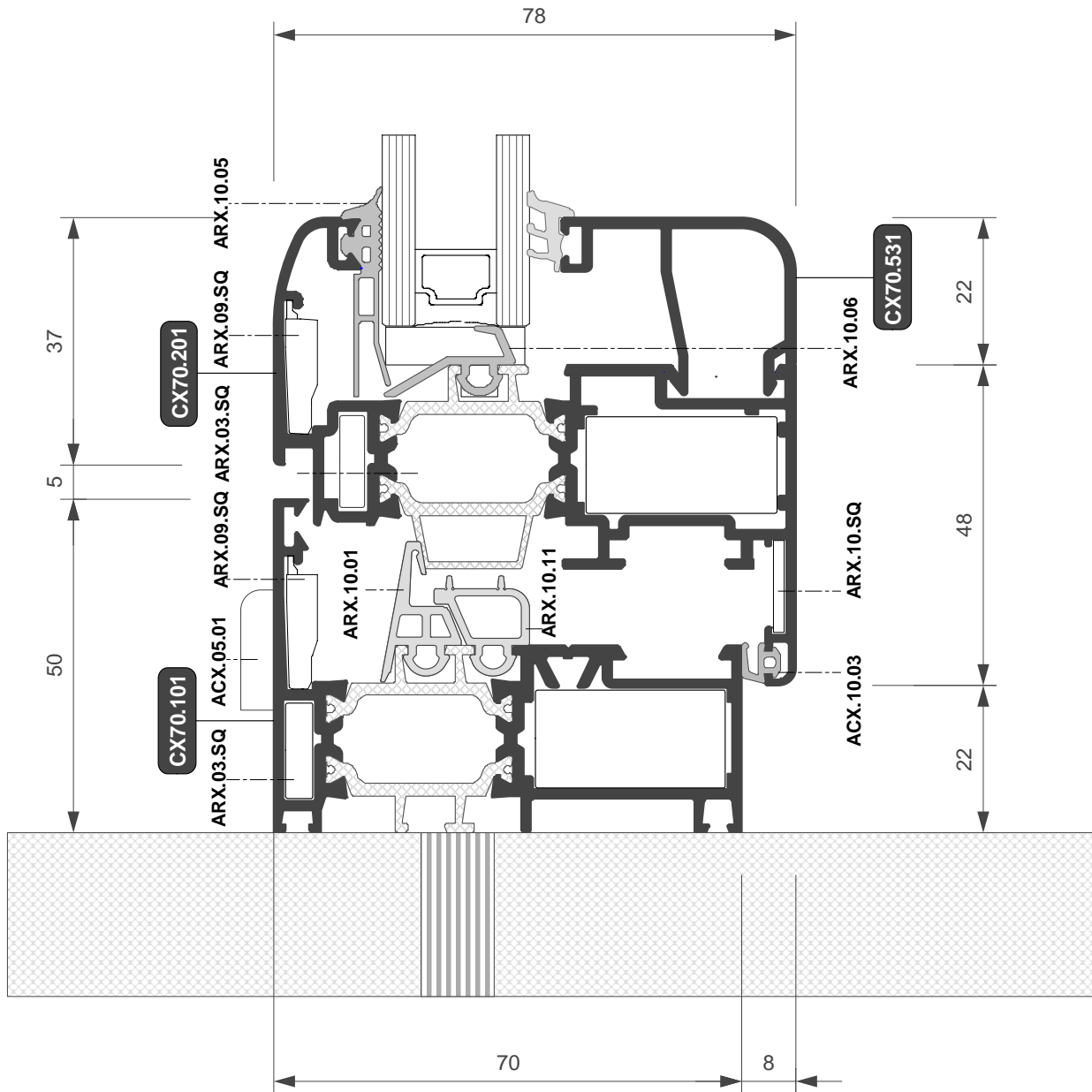

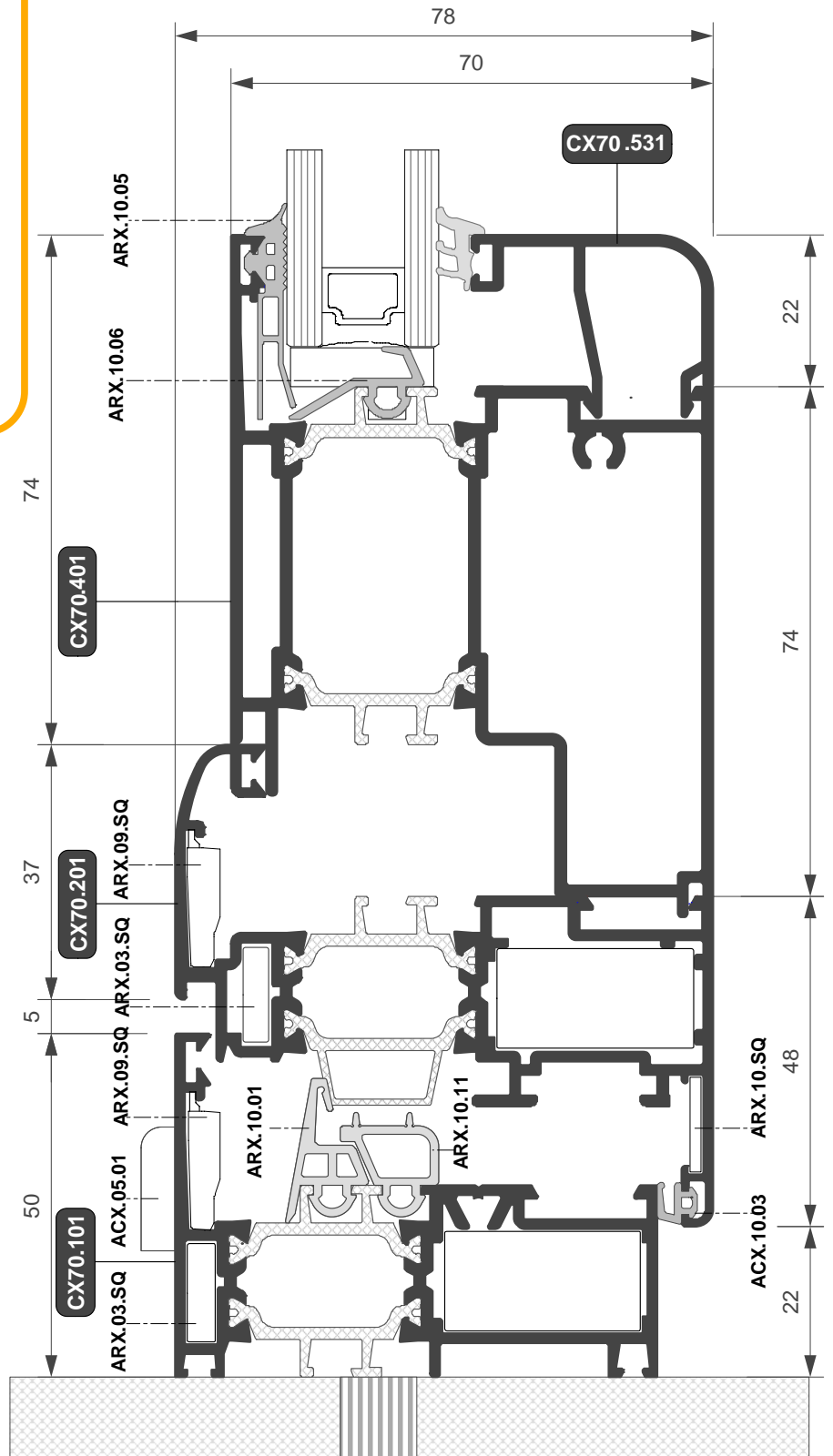

 PORTA BALCONE
 A 2 ANTE

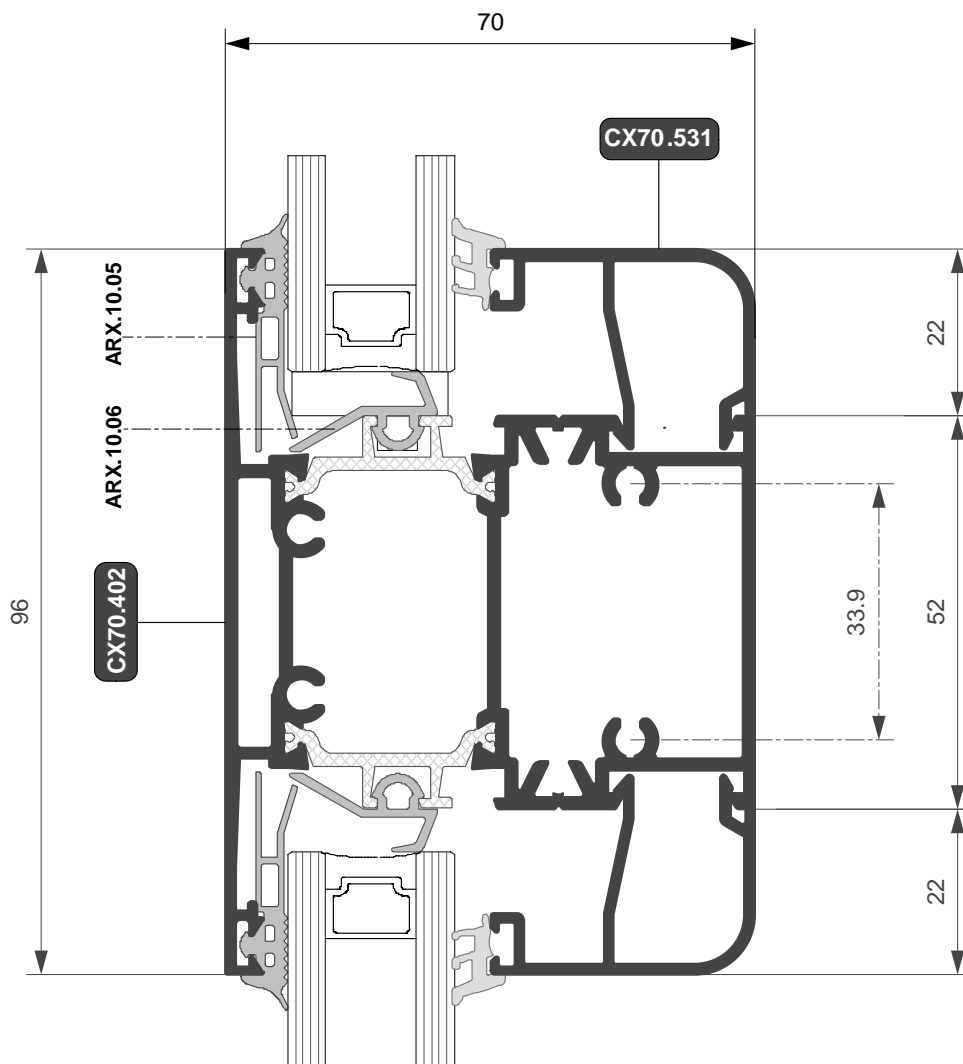

PORTA BALCONE
A 2 ANTE

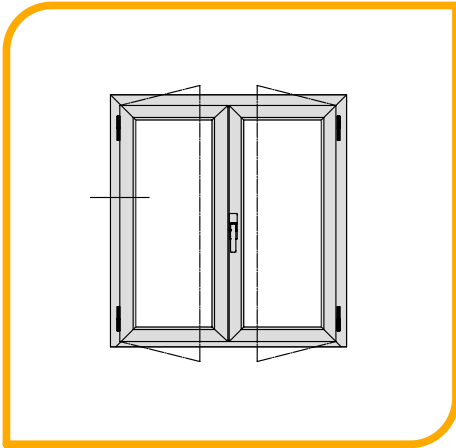



FINESTRA A 2 ANTE

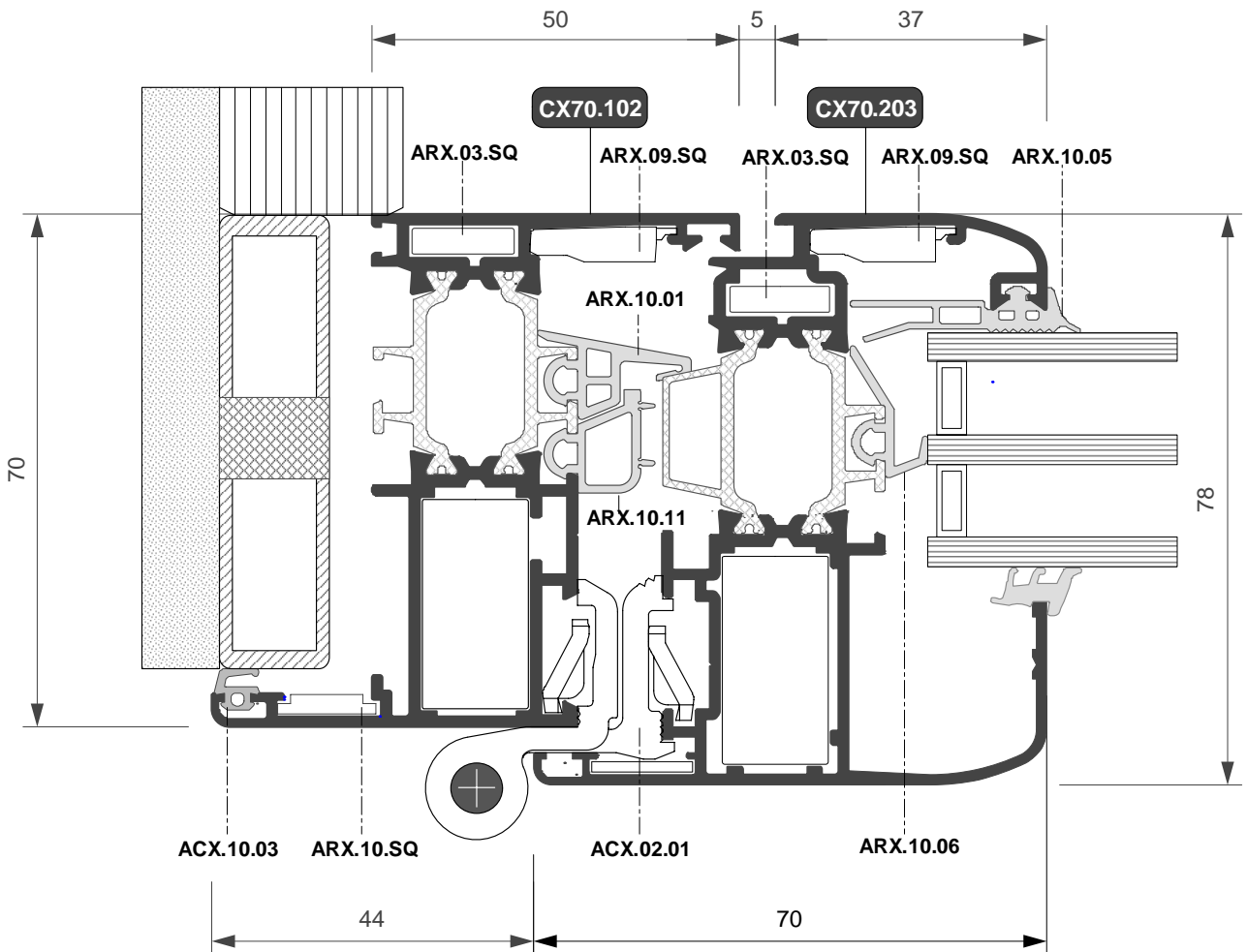

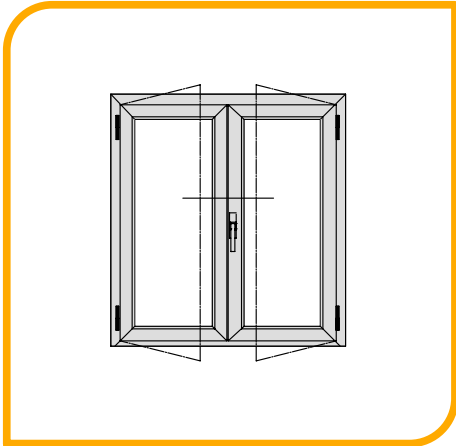

FINESTRA A 2 ANTE

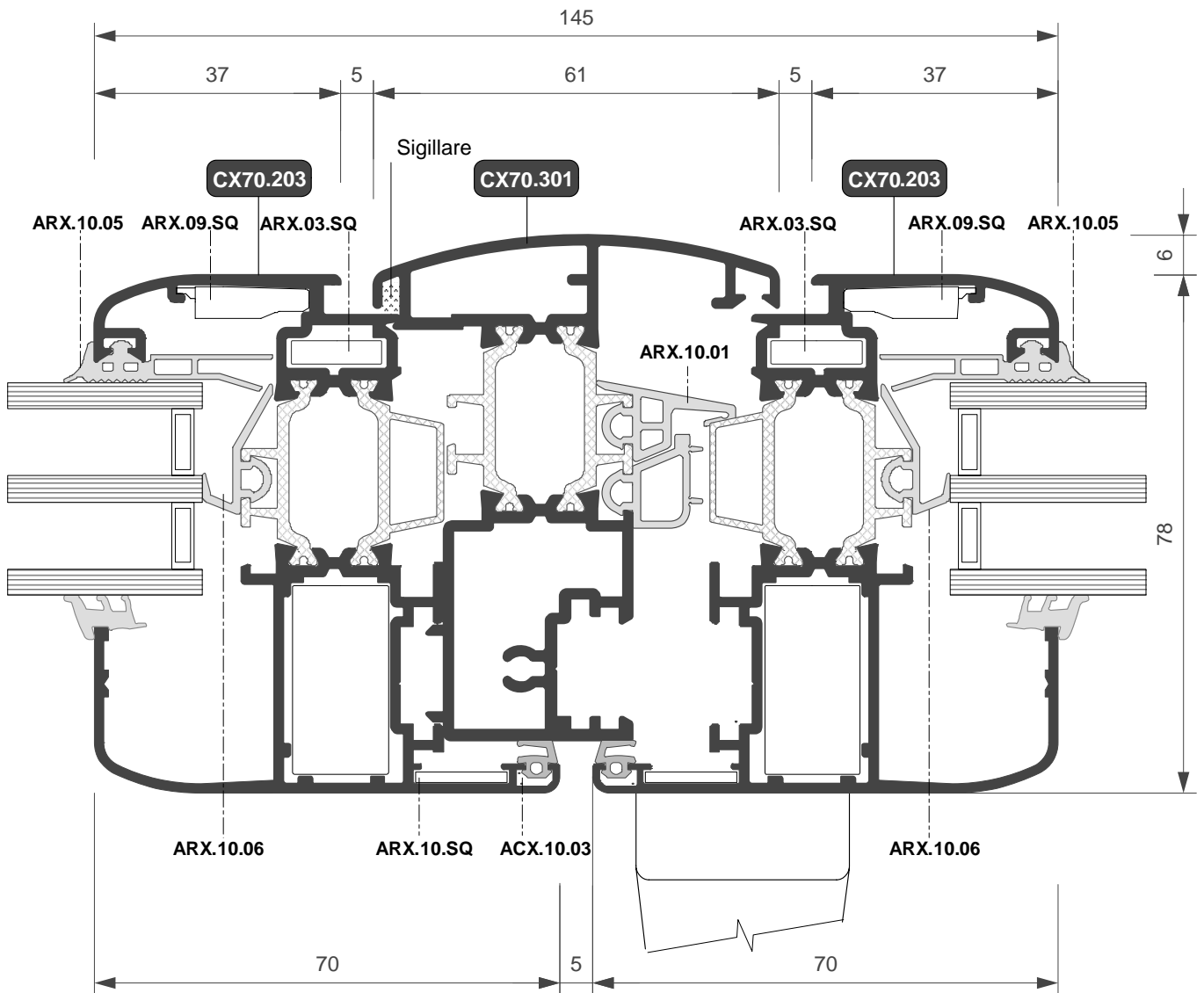

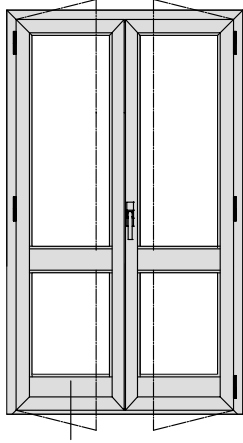
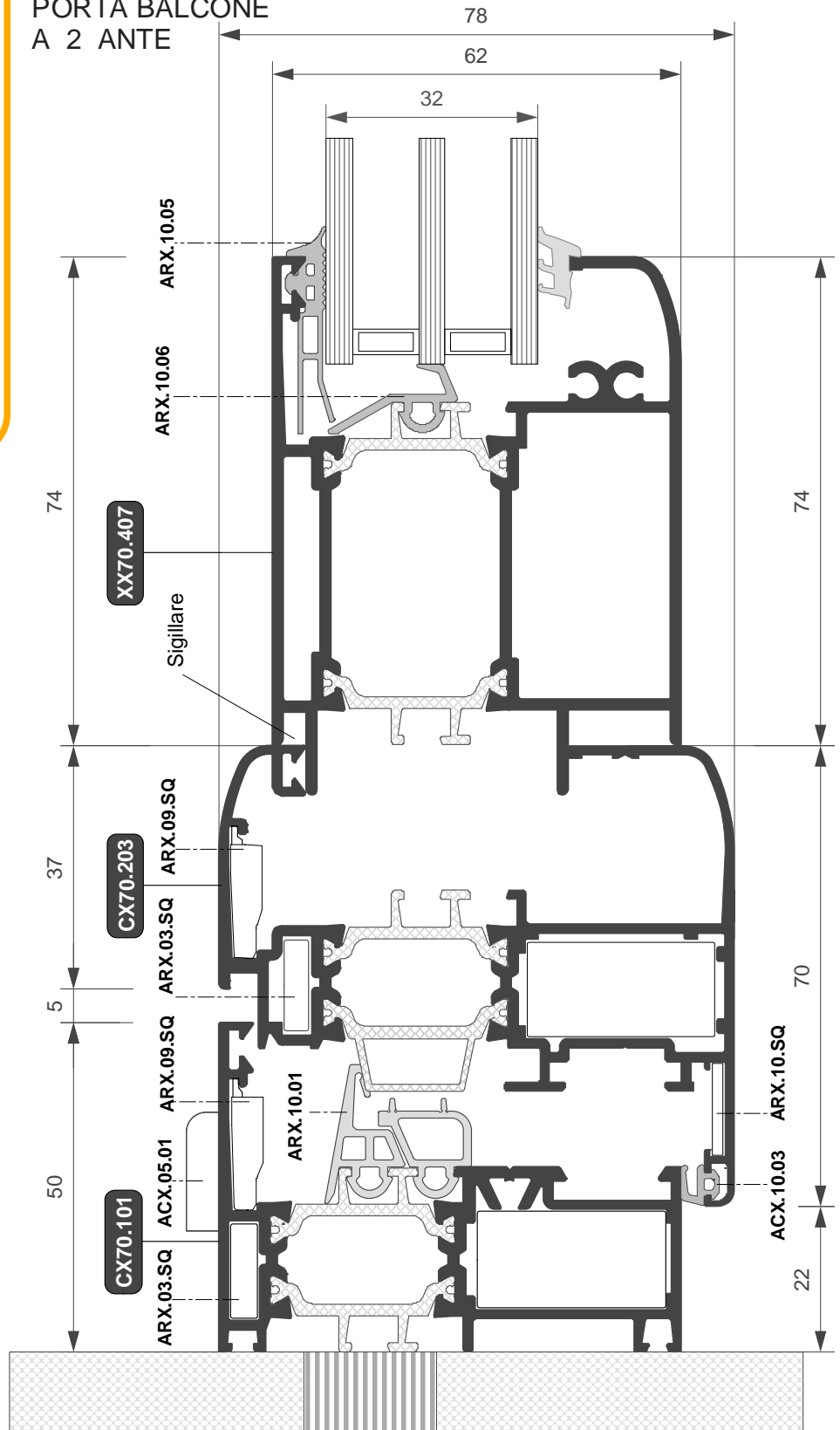

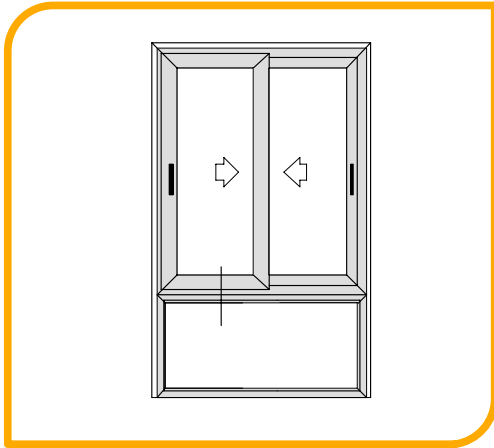
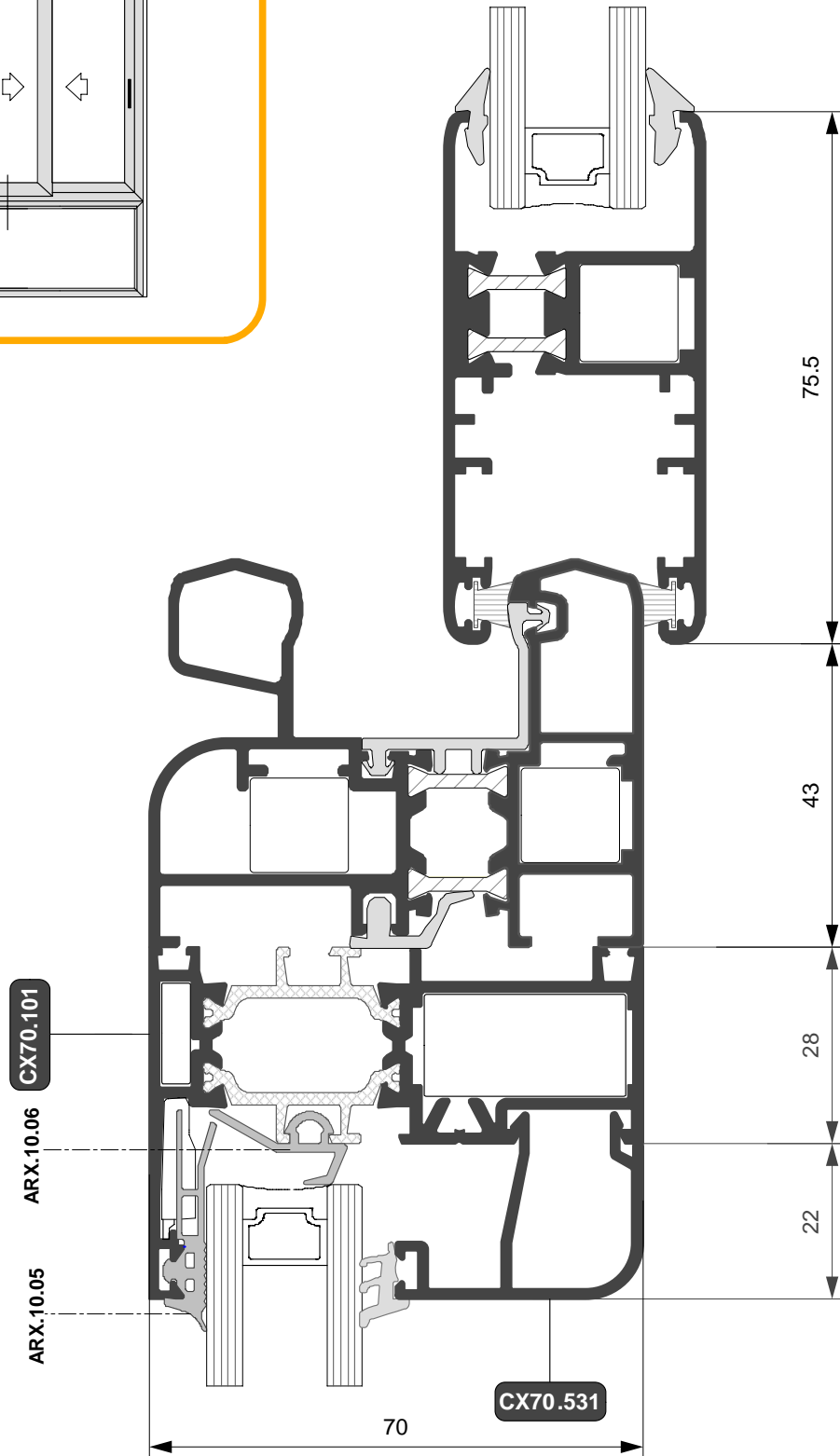
**PORTA BALCONE
A 2 ANTE**

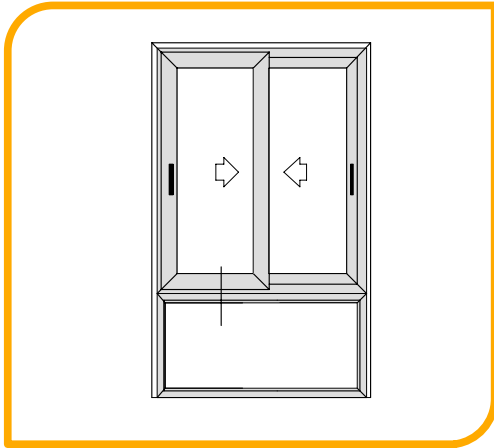
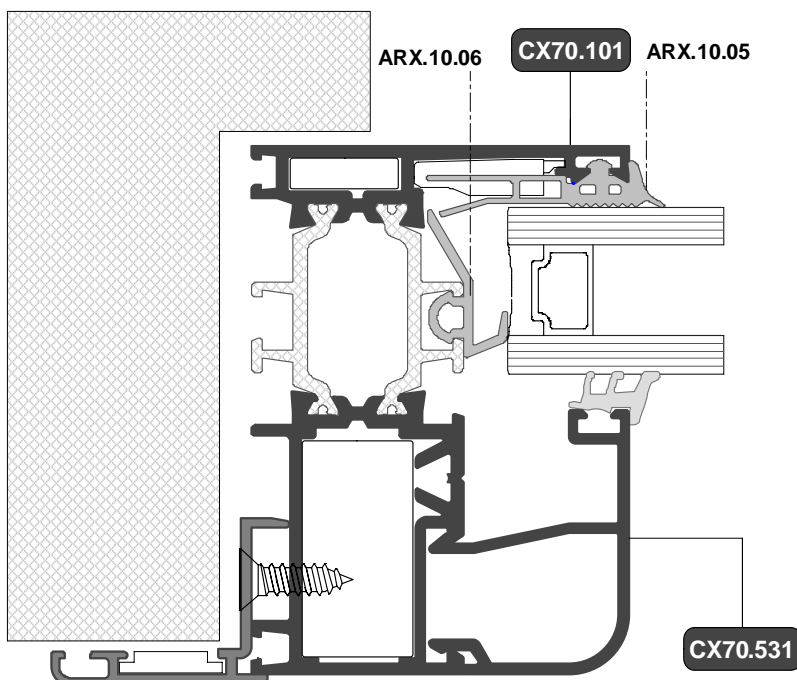
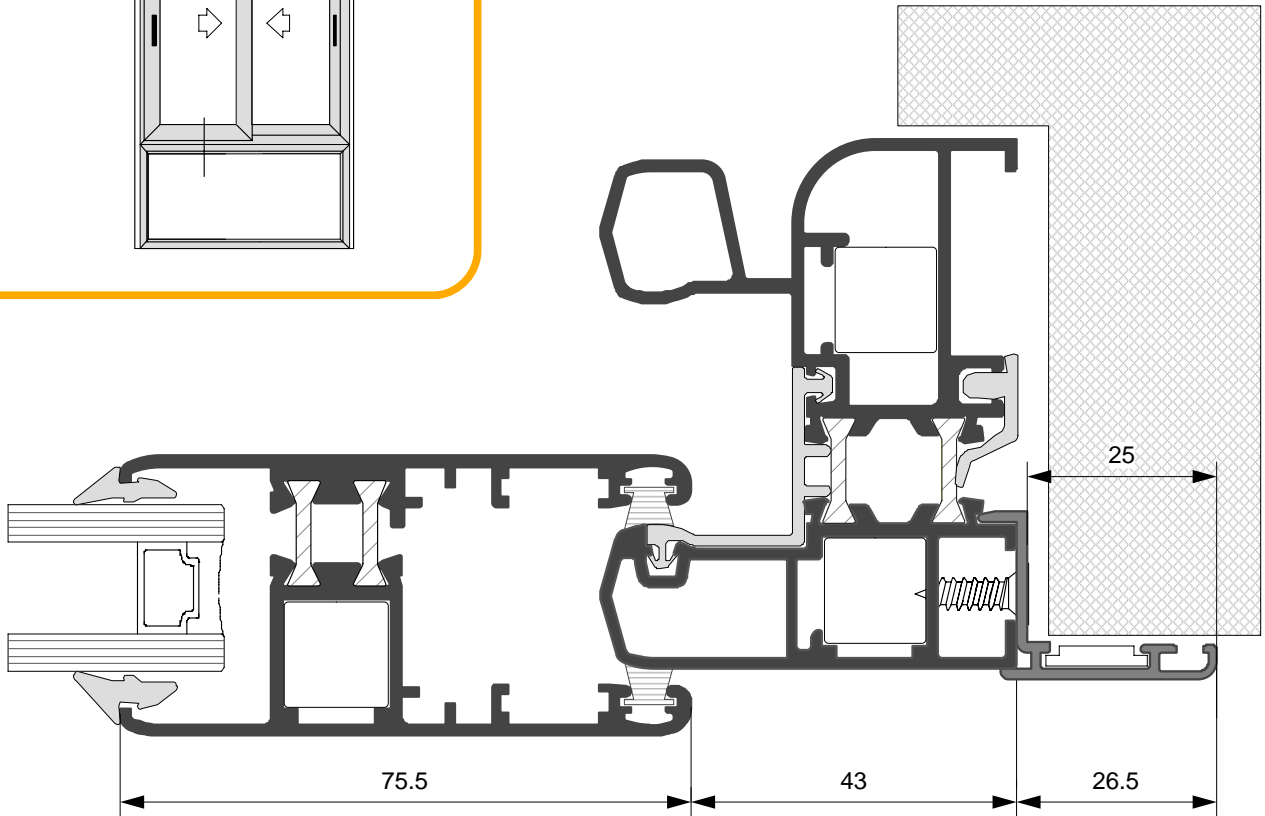

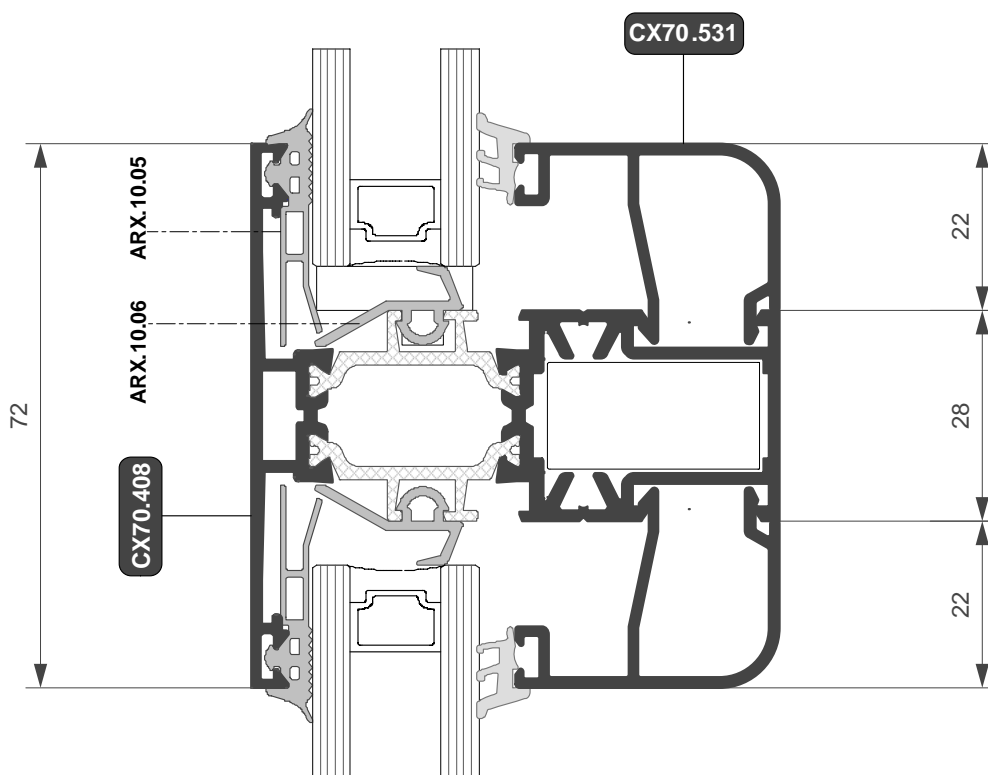
ABBINAMENTO SCORREVOLE

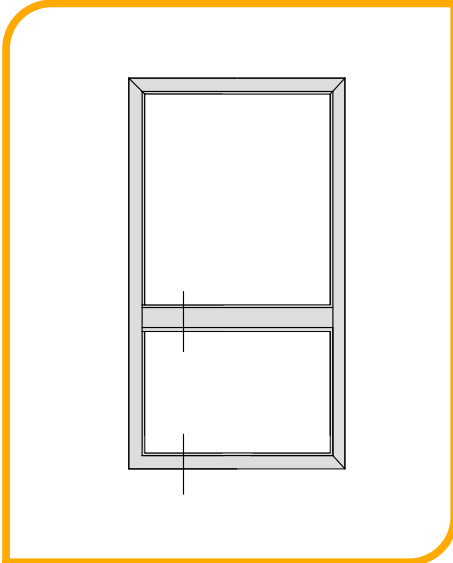

ABBINAMENTO SCORREVOLE

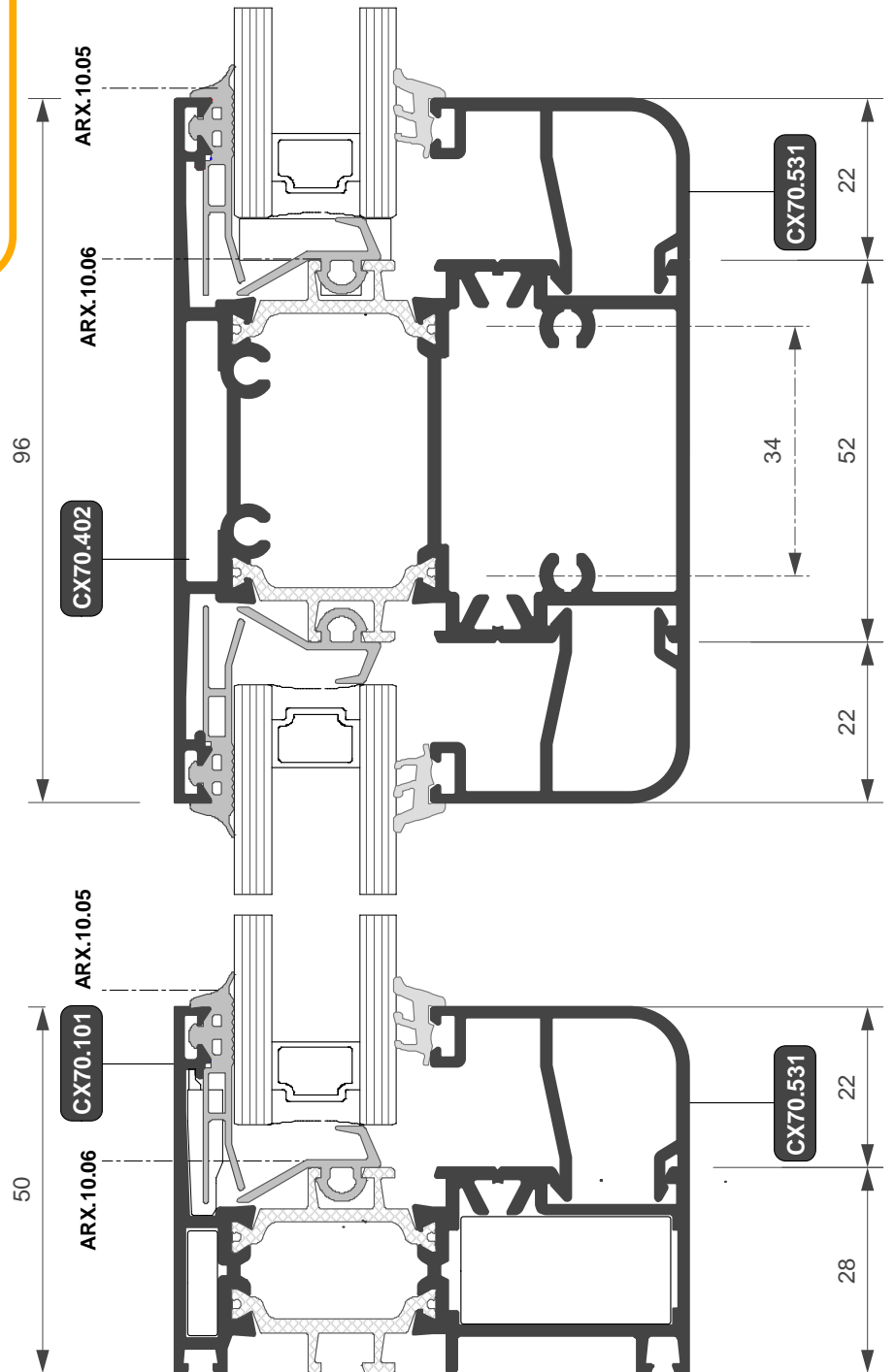

 PORTA BALCONE
 A 2 ANTE

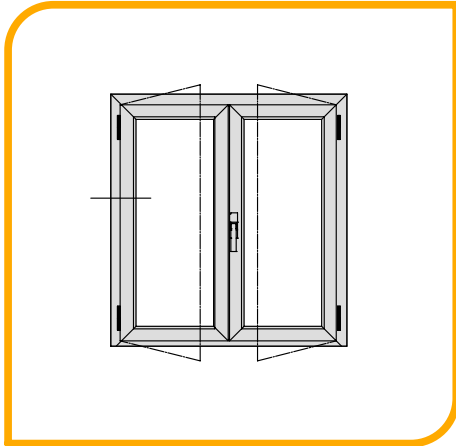

FISSO



Ferramenta a nastro

FINESTRA A 2 ANTE

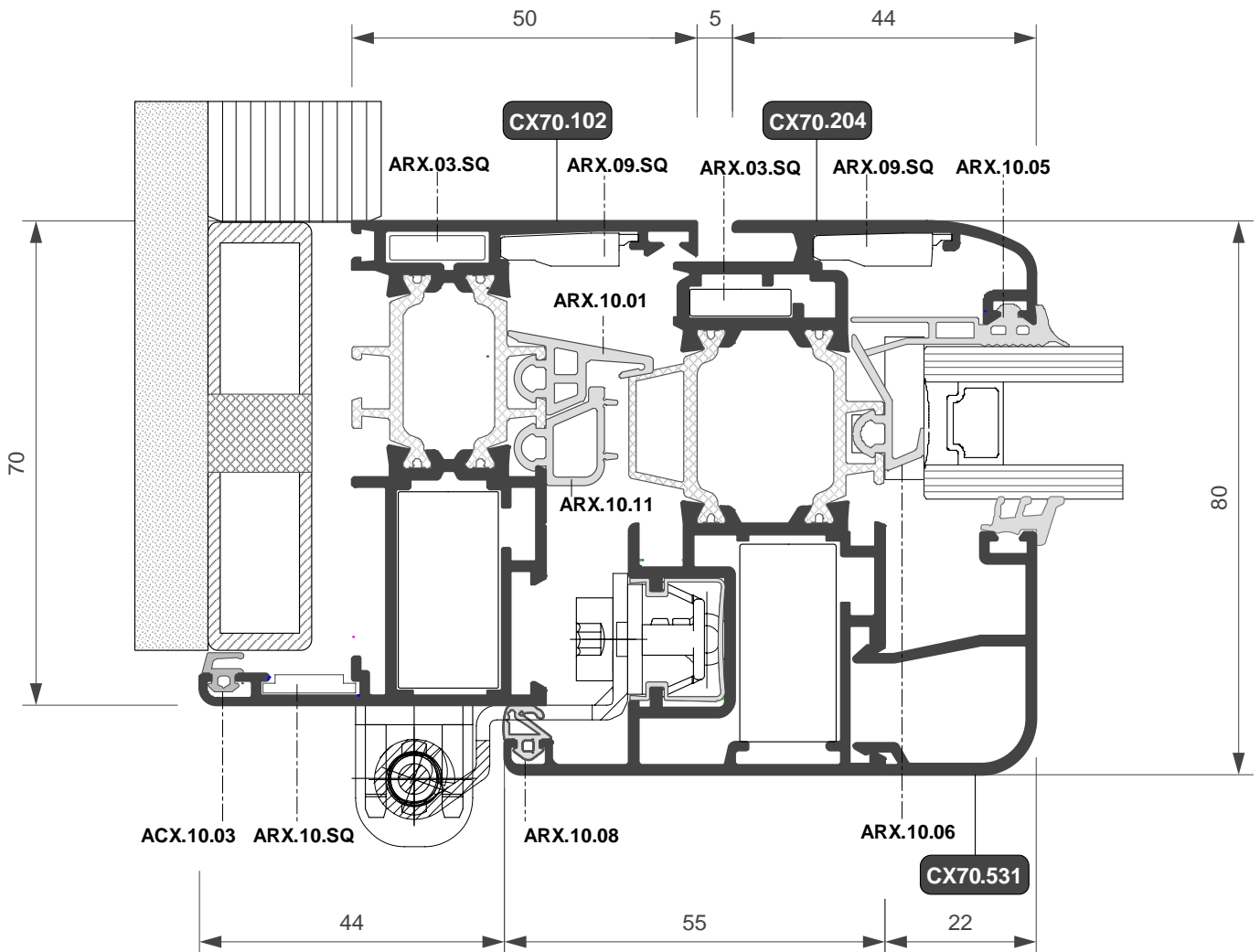

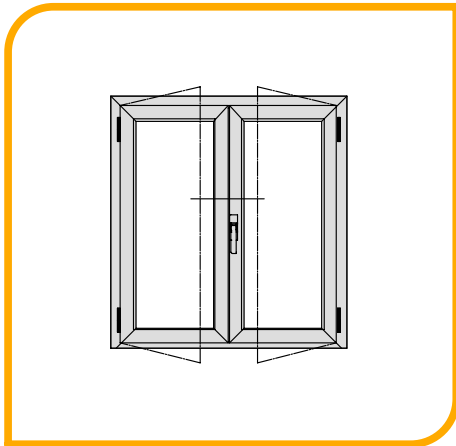
Ferramenta a nastro

FINESTRA A 2 ANTE

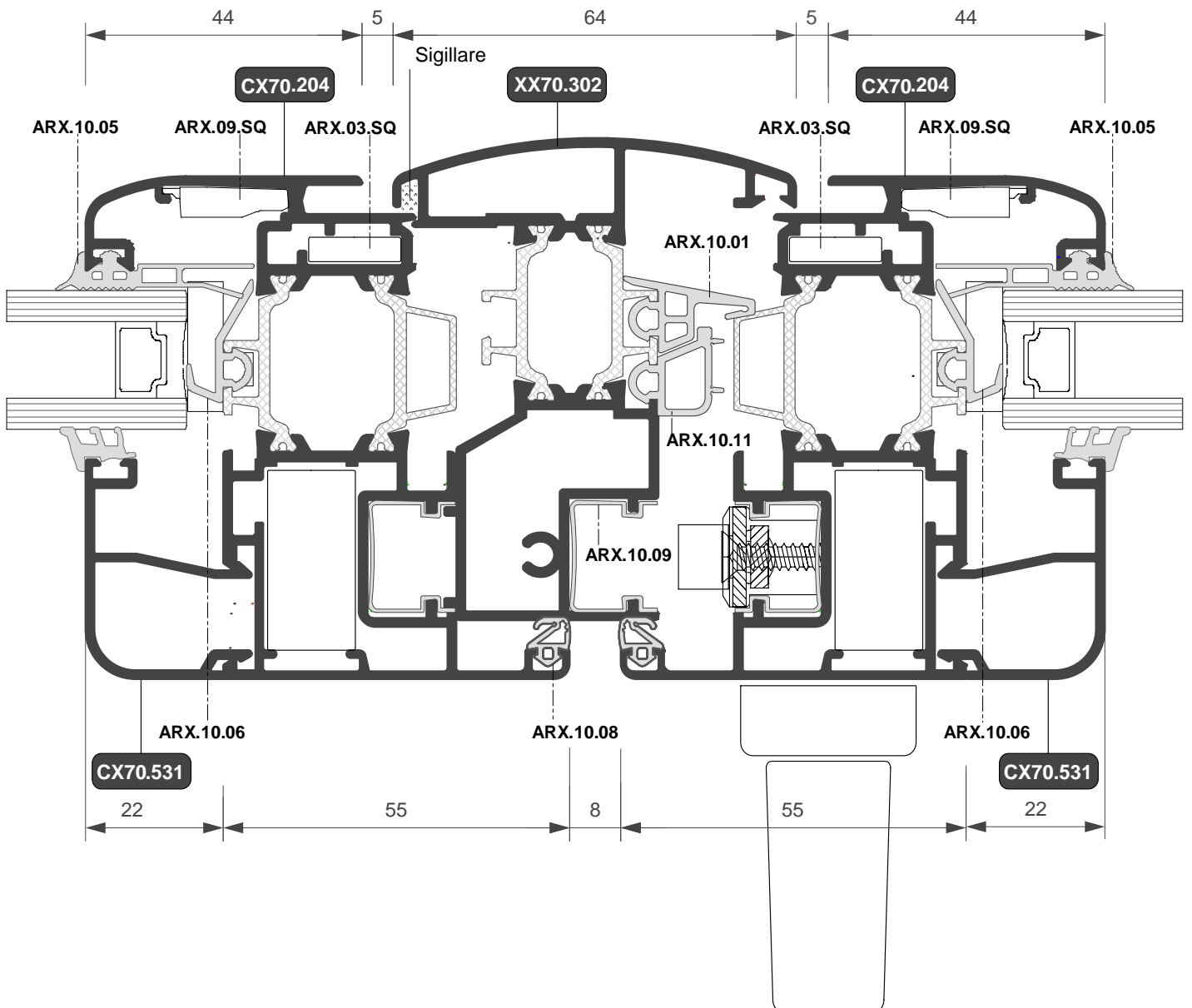

Ferramenta a nastro



PORTA BALCONE
A 2 ANTE

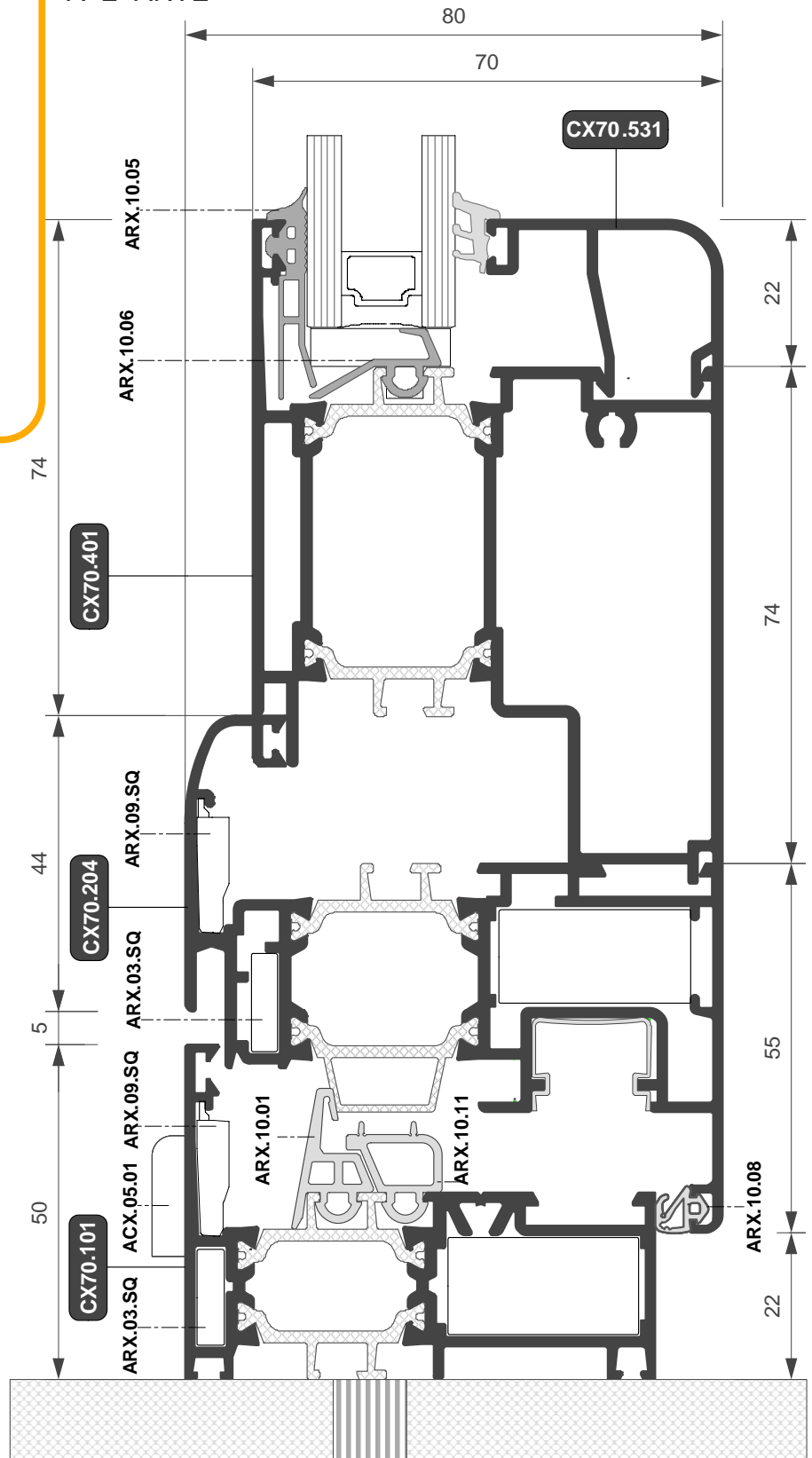

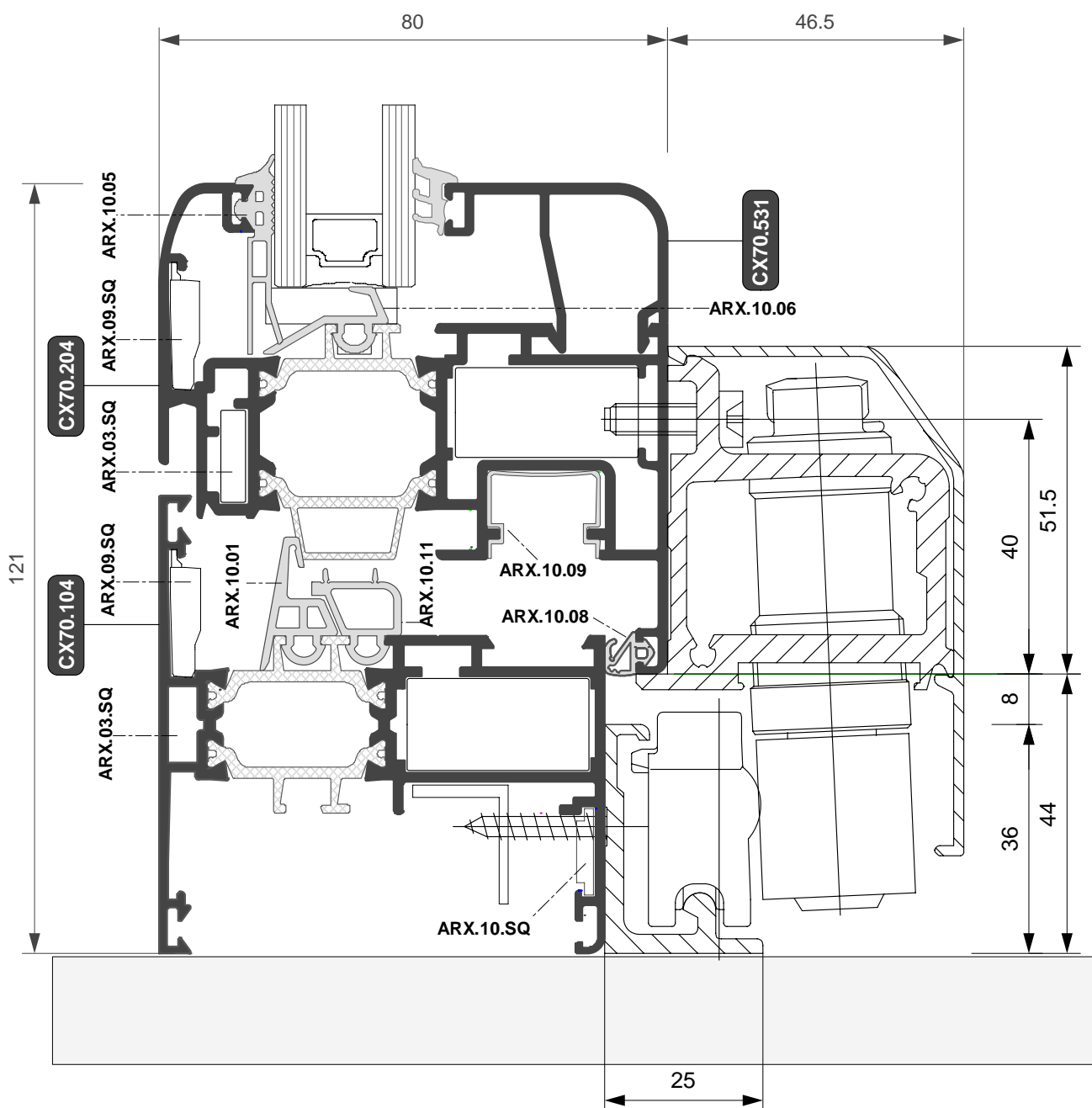
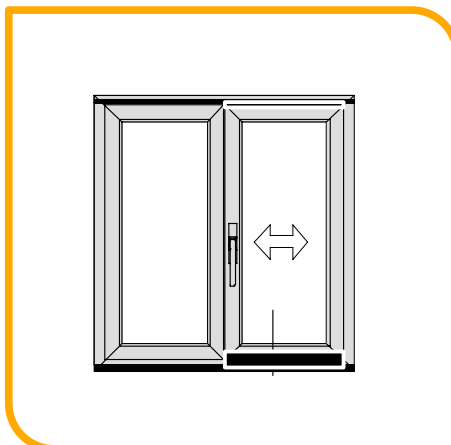
**FINESTRA A 2 ANTE
 SCORREVOLE PARALLELO**

FINESTRA A 2 ANTE SCORREVOLE PARALLELO

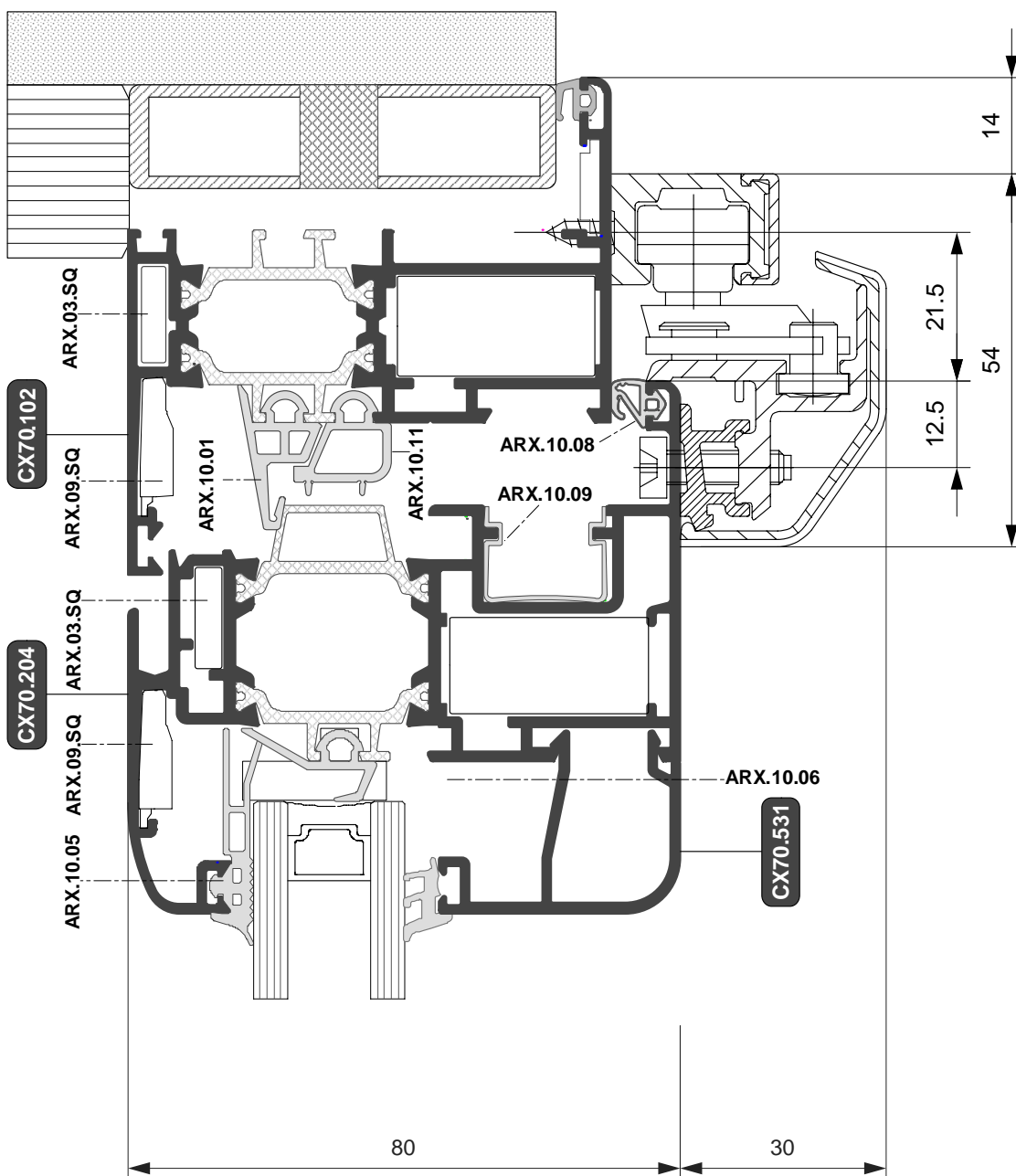
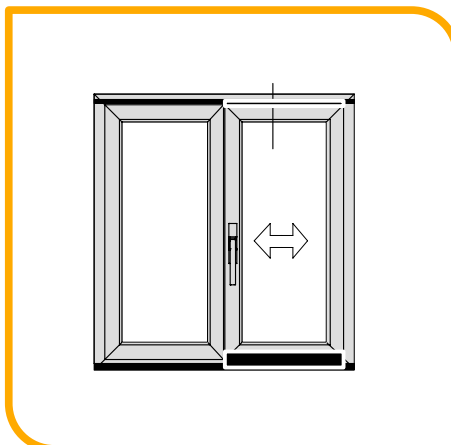

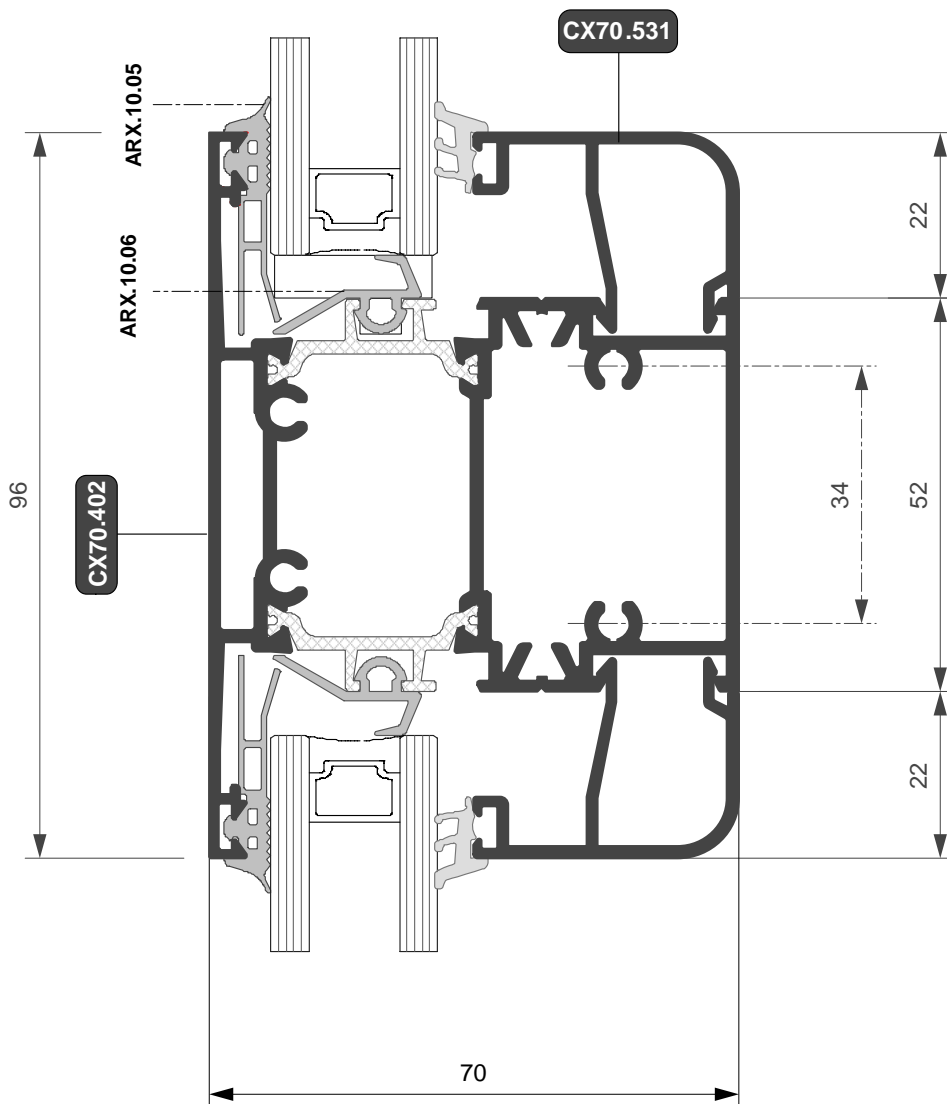

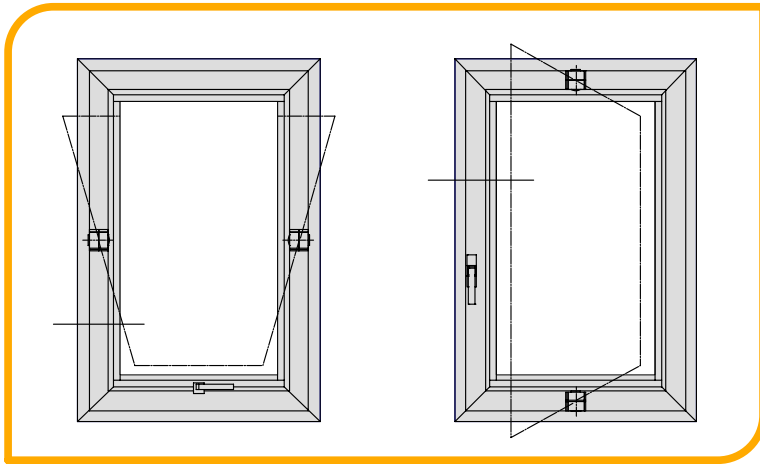
 PORTA BALCONE
 A 2 ANTE

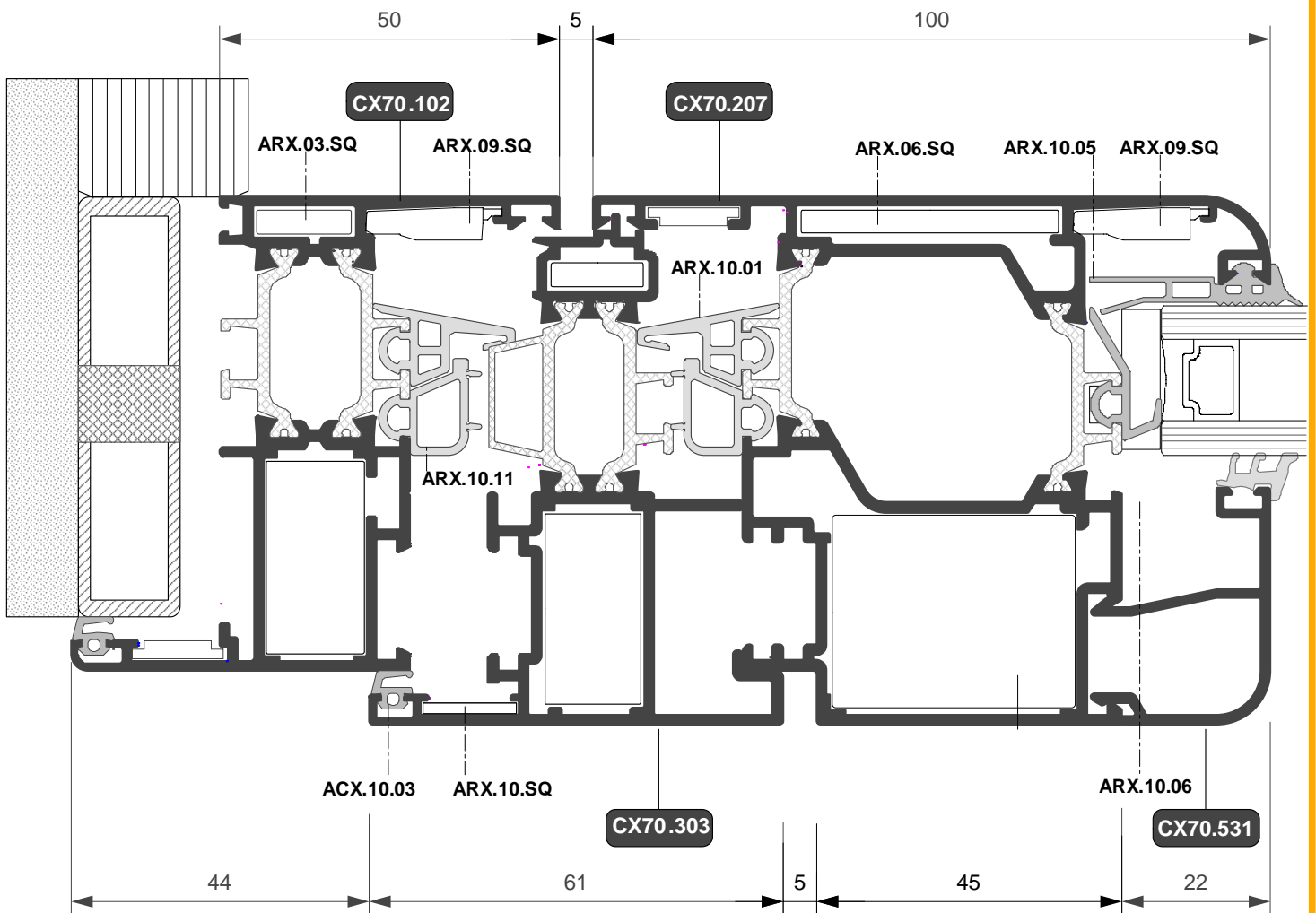

FINESTRA BILICO
ORIZZONTALE E VERTICALE

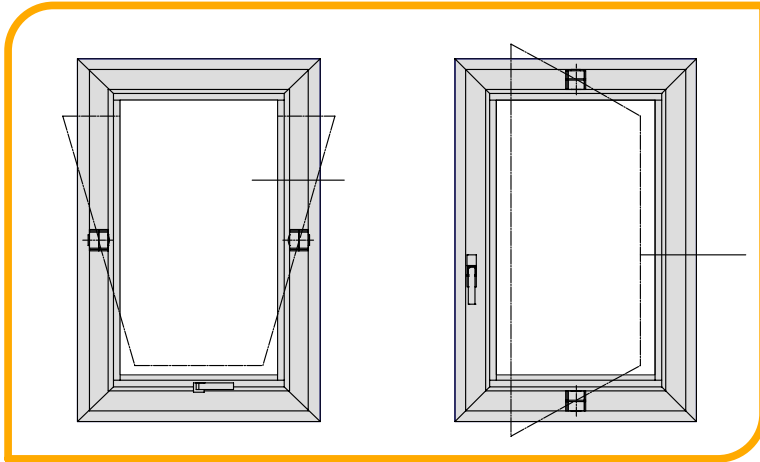



FINESTRA BILICO
ORIZZONTALE E VERTICALE

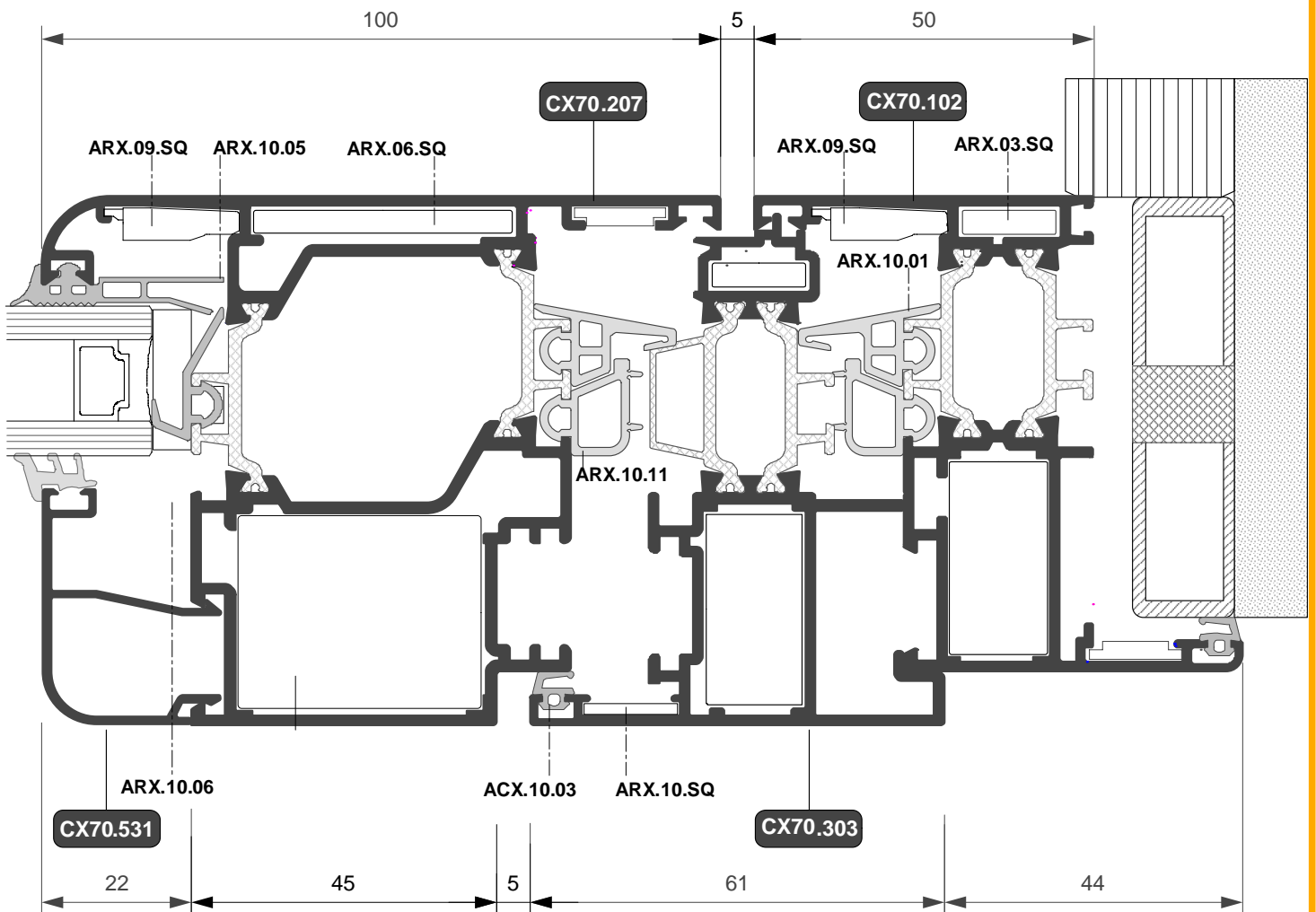

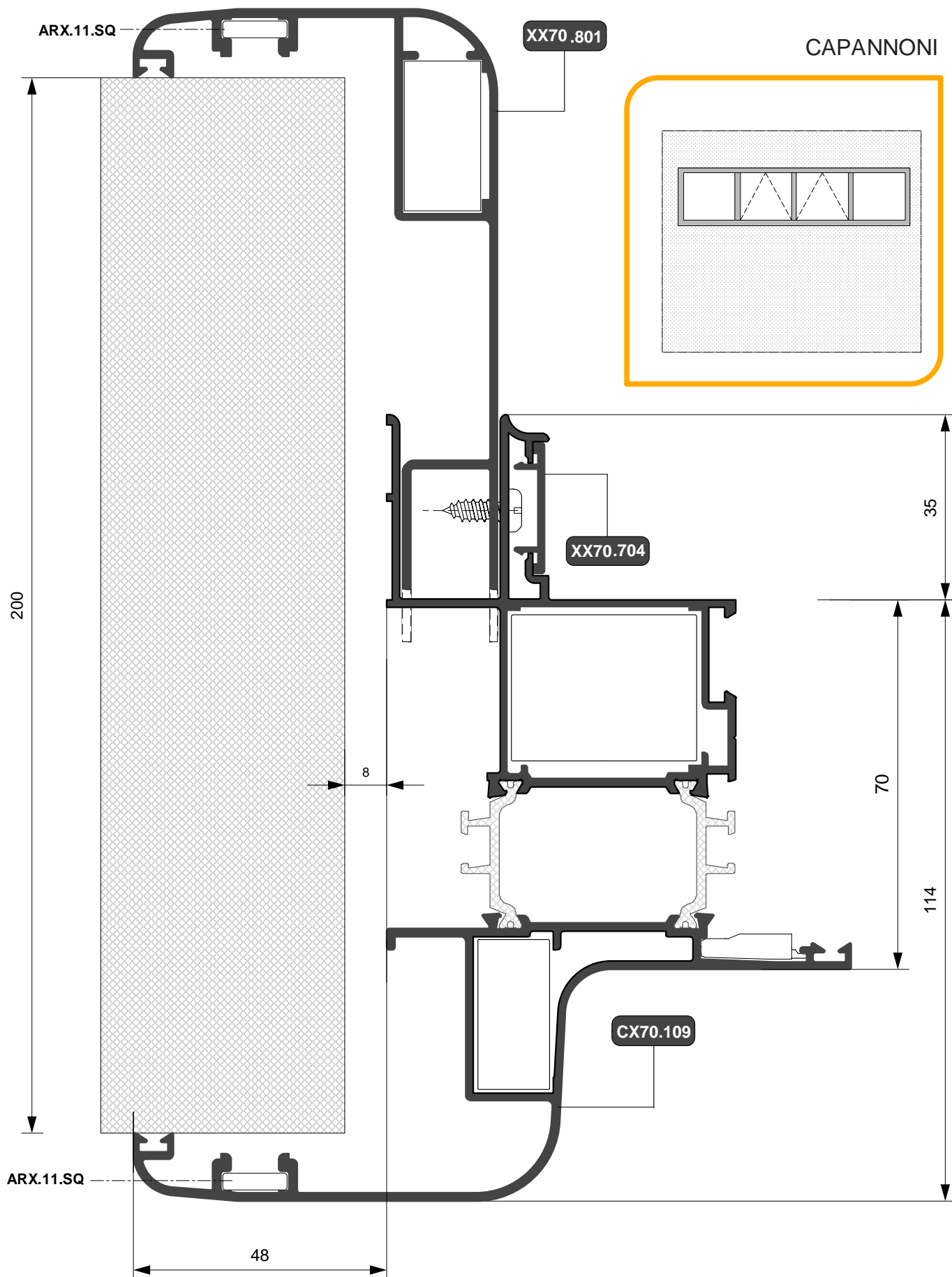

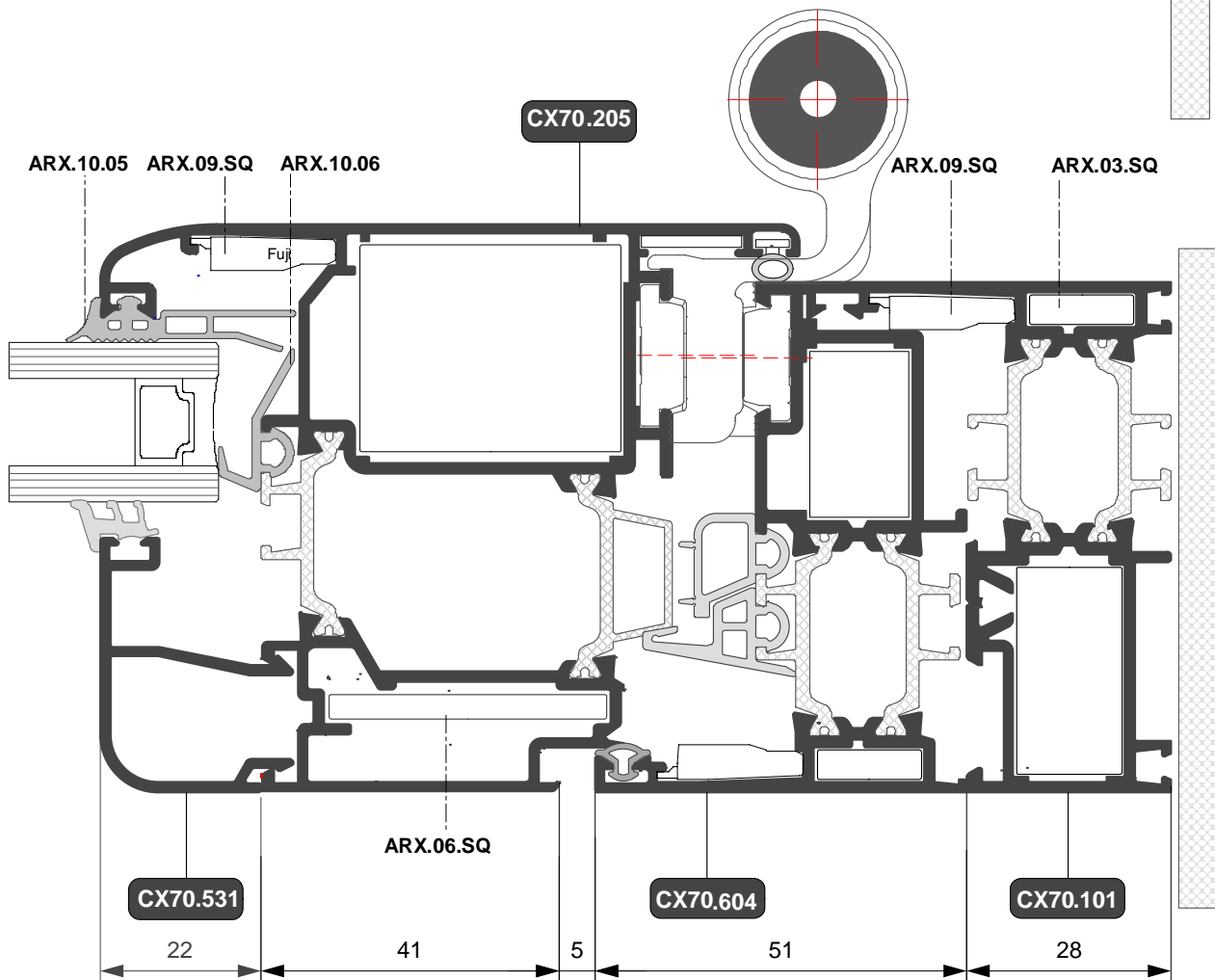
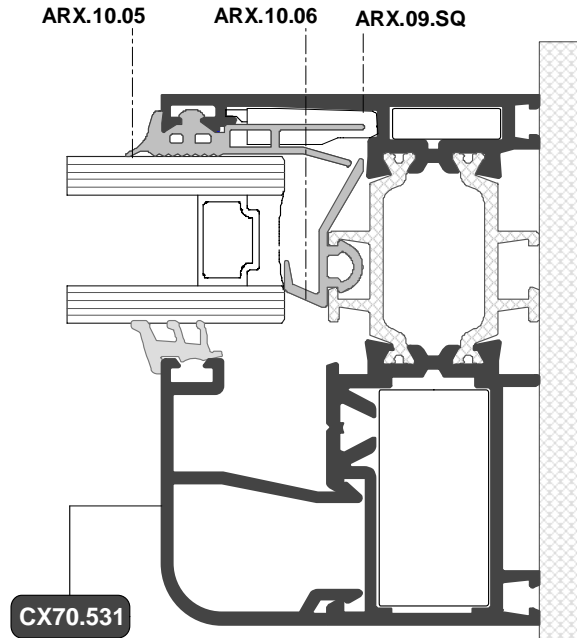
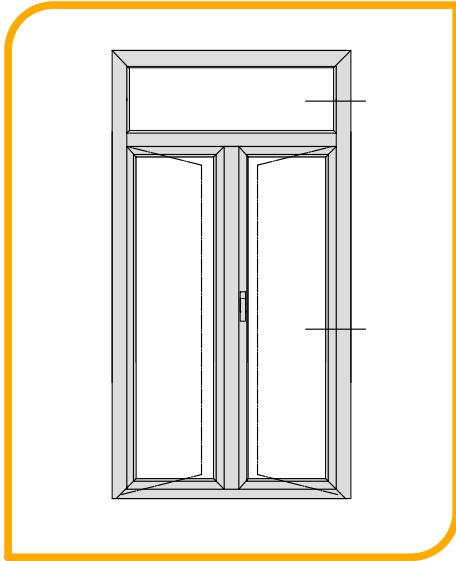
PORTA A 2 ANTE
Apertura esterna

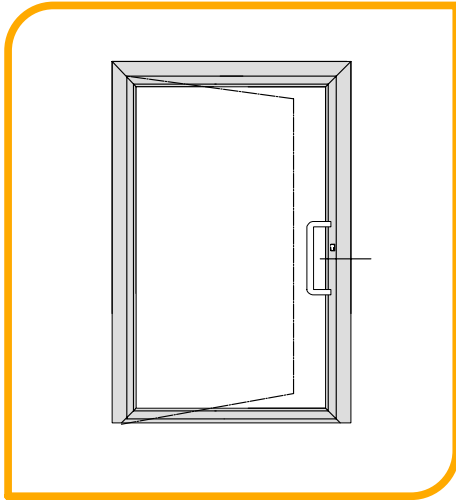
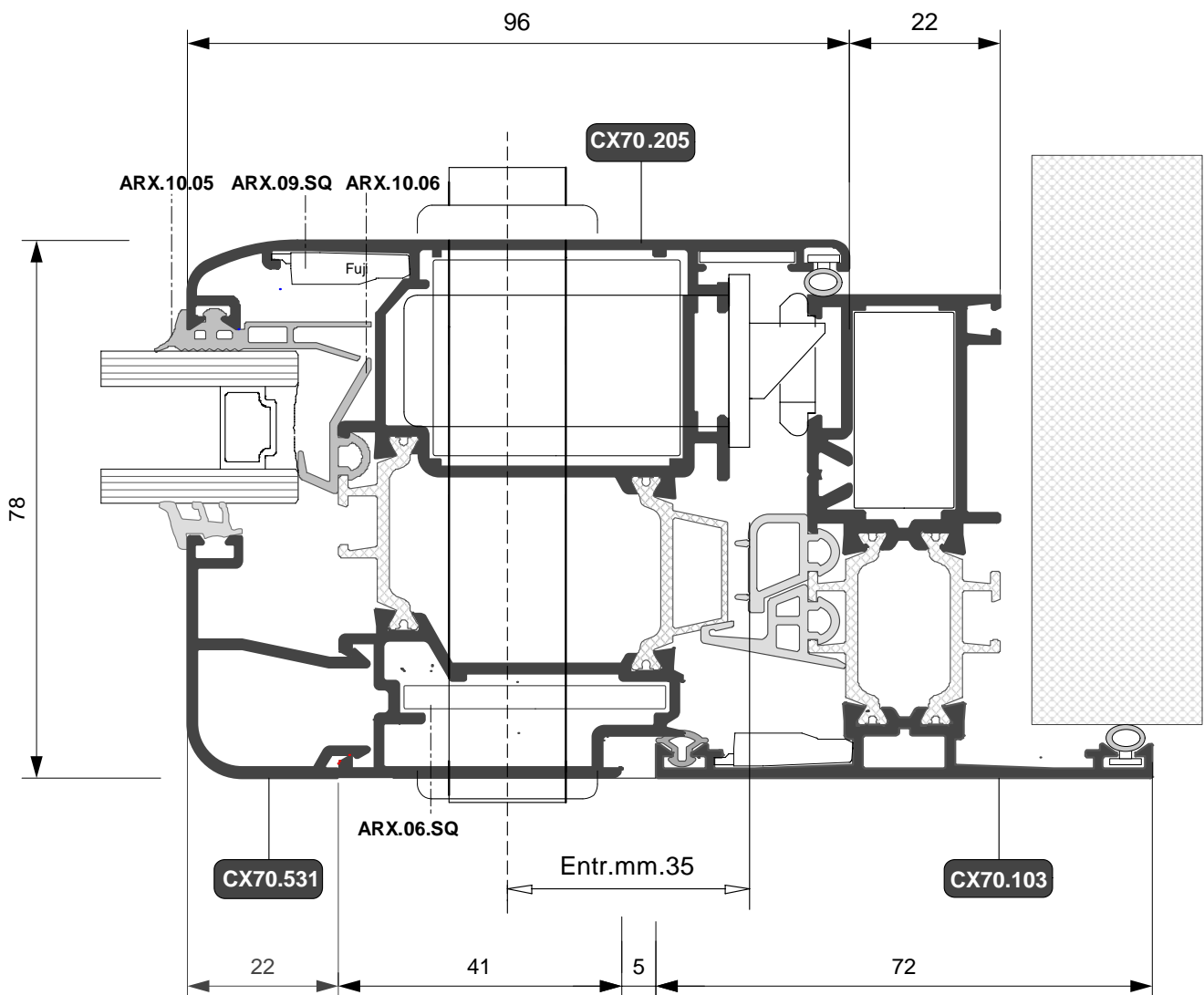

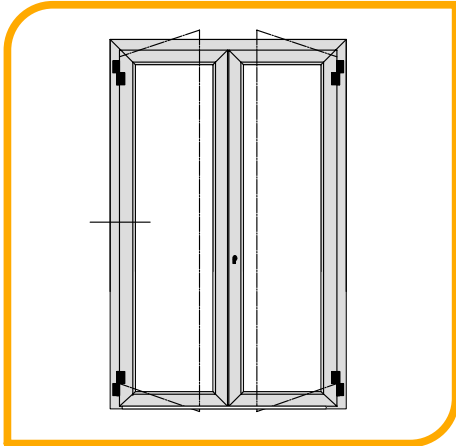
 PORTA A 2 ANTE
 Apertura esterna

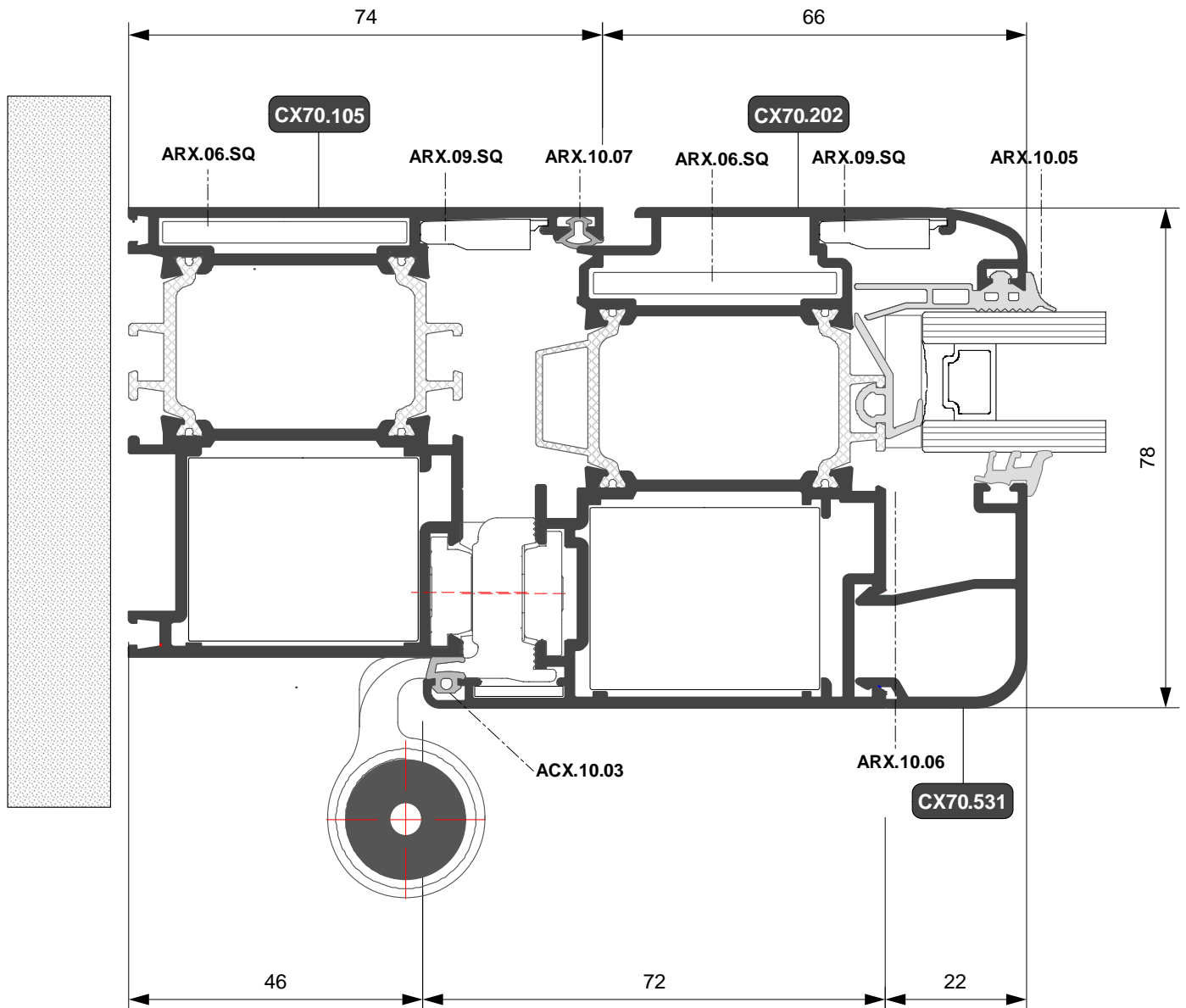

PORTA INGRESSO
A 2 ANTE

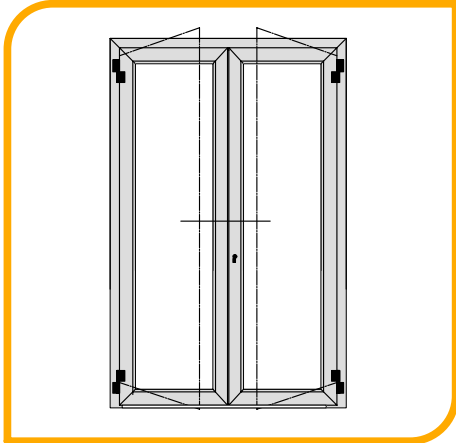



PORTA INGRESSO
A 2 ANTE

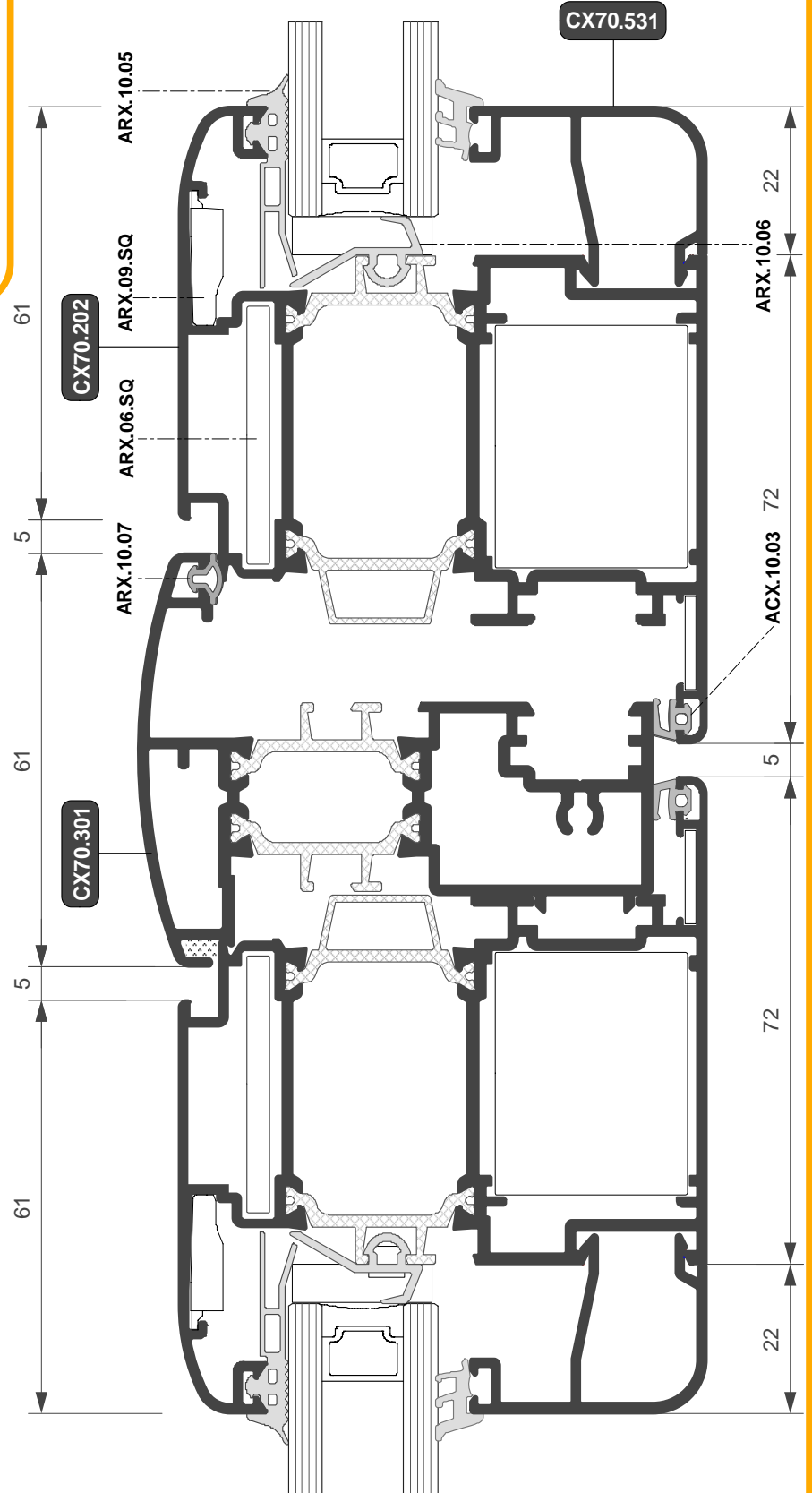

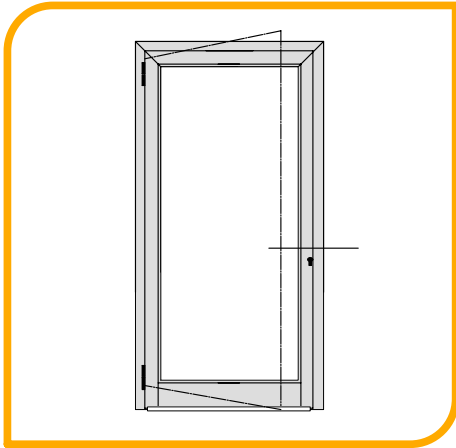

PORTA INGRESSO

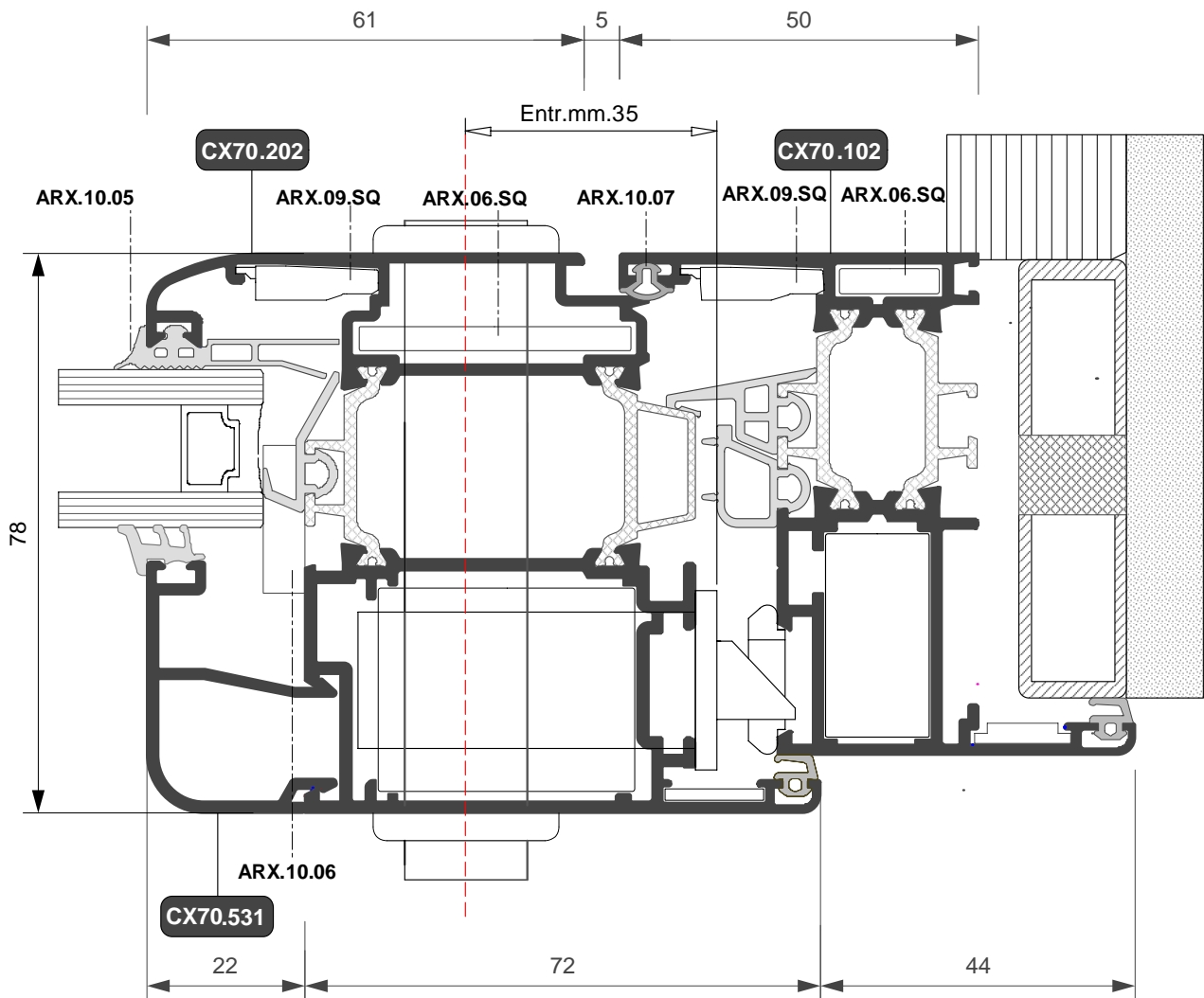

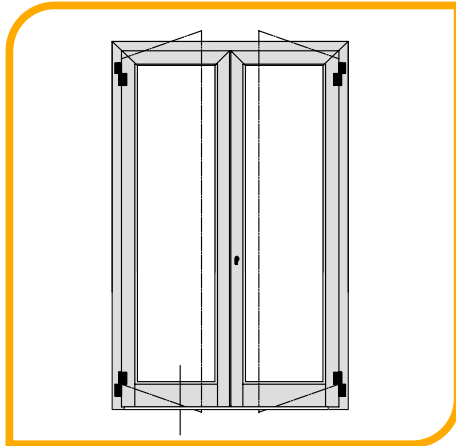
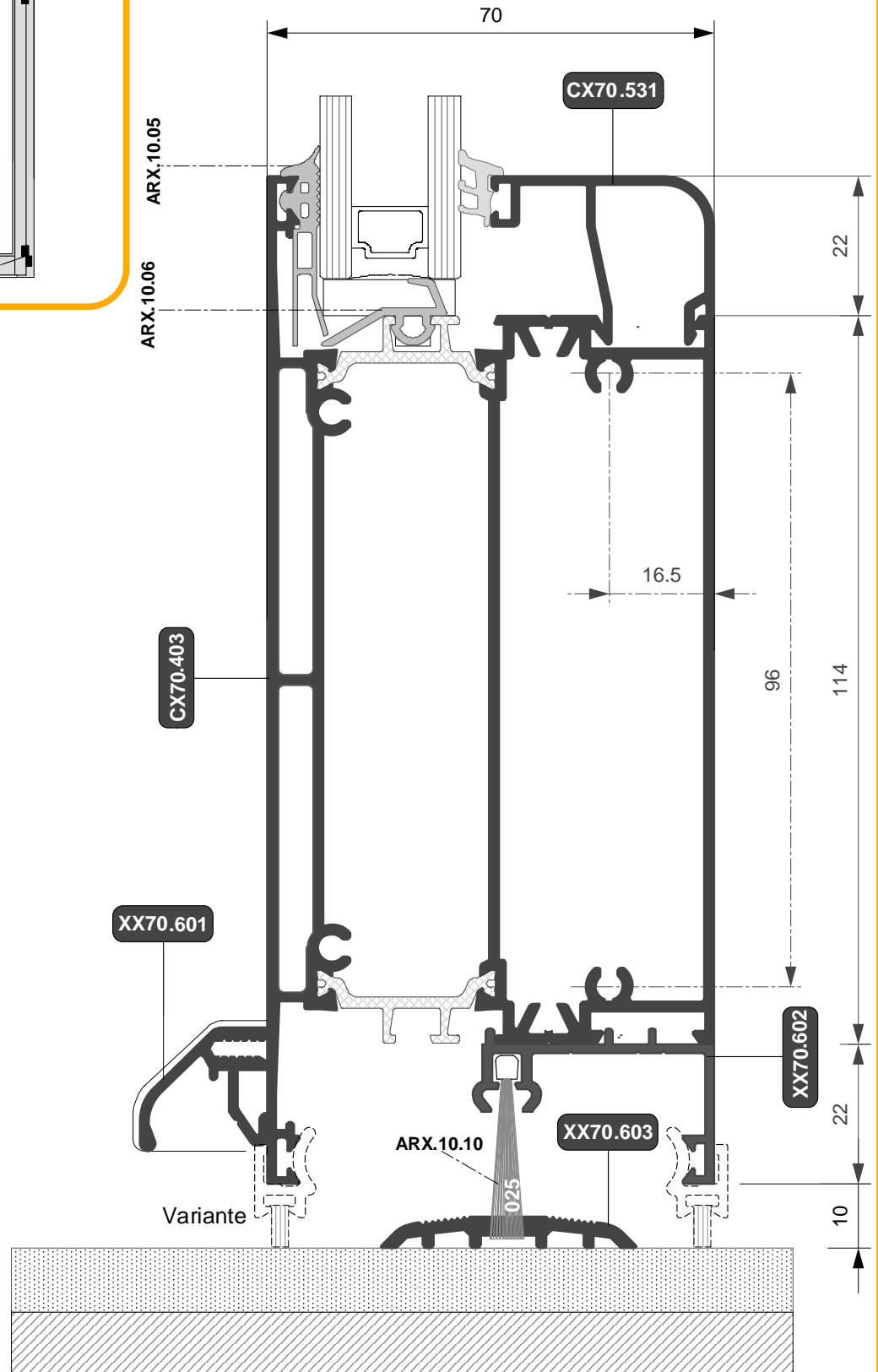

**PORTA INGRESSO
A 2 ANTE**

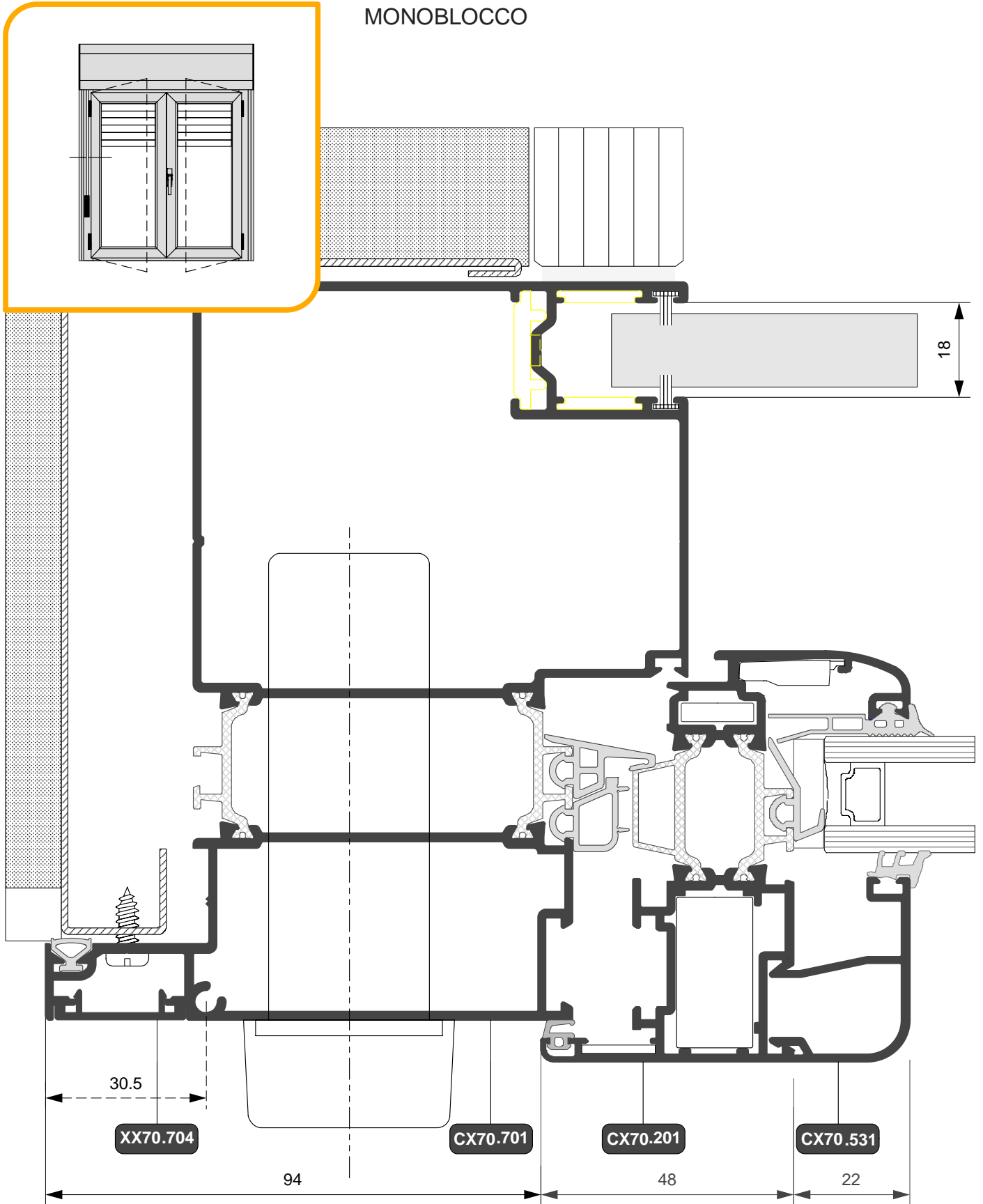
MONOBLOCCO

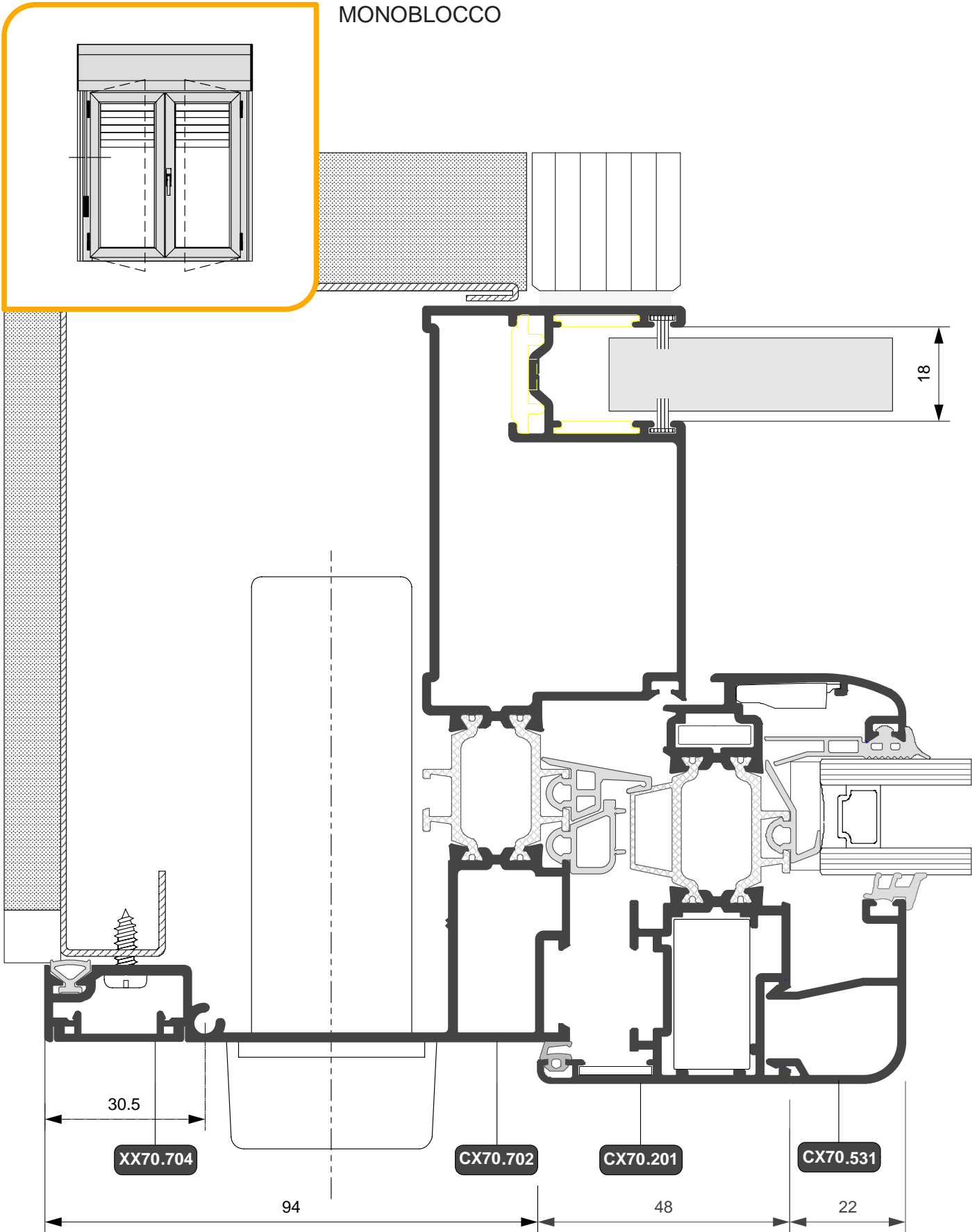

MONOBLOCCO



MONOBLOCCO

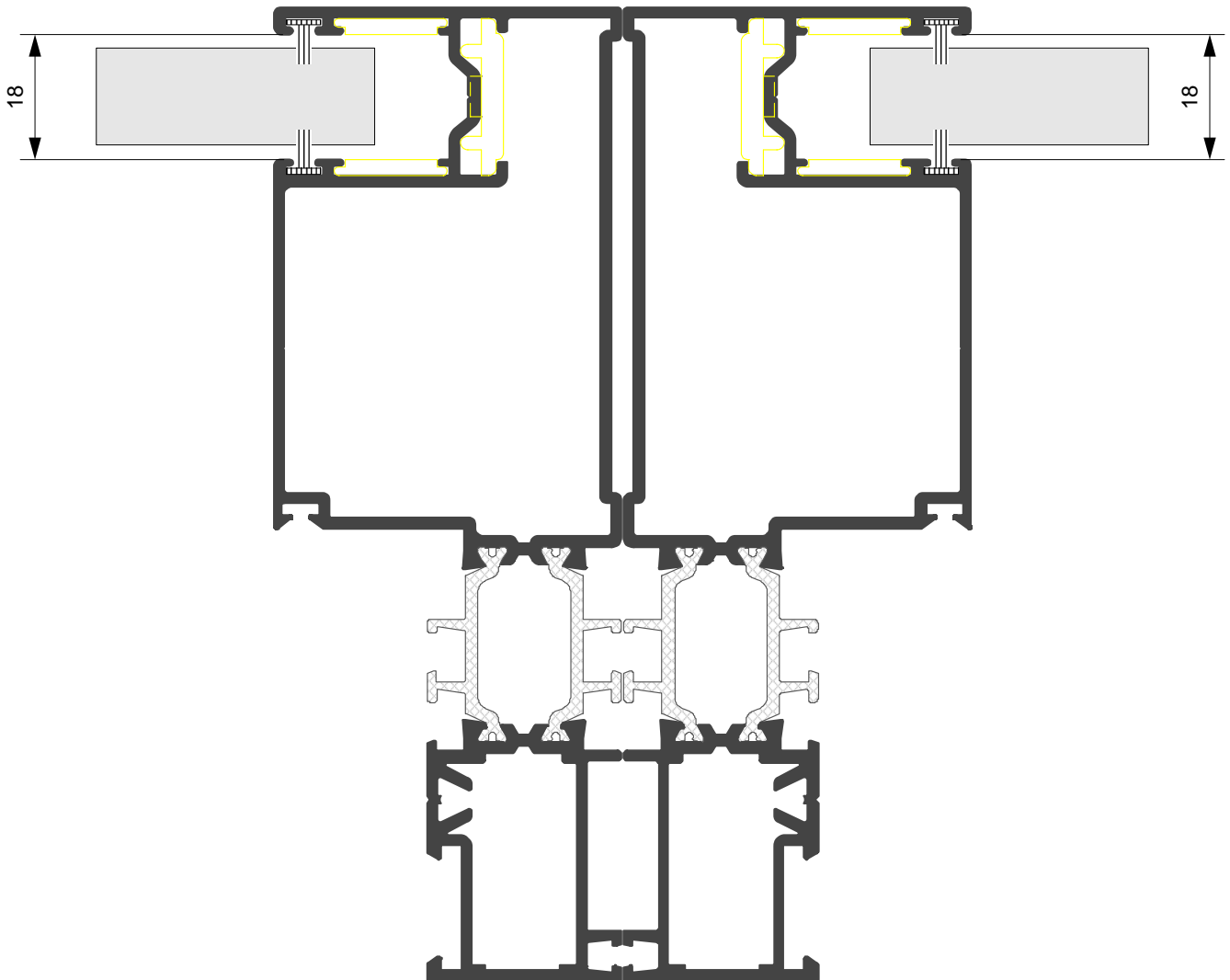
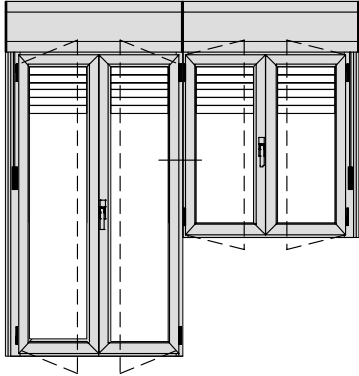

MONOBLOCCO

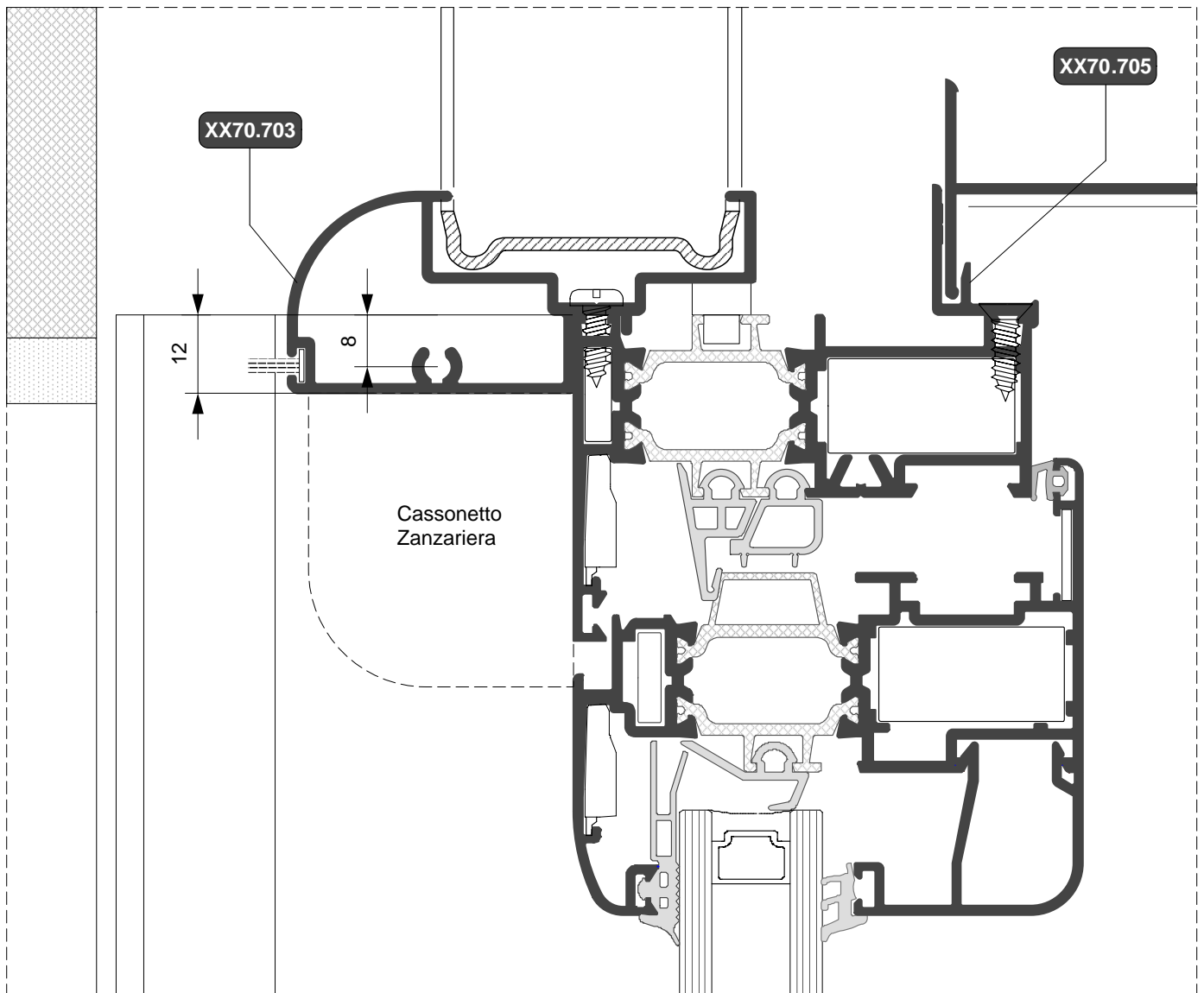
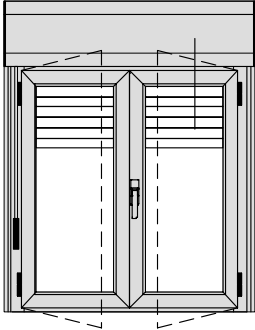

Monoblocco

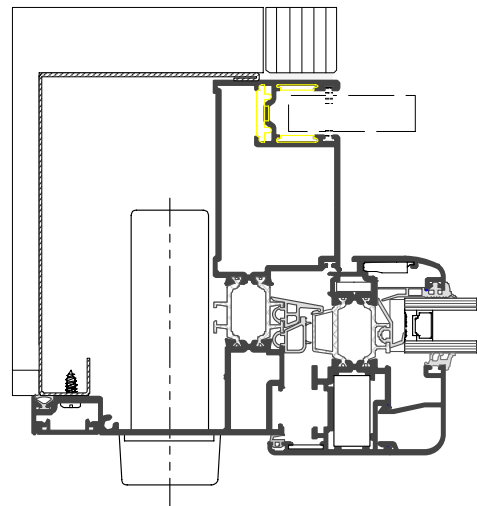
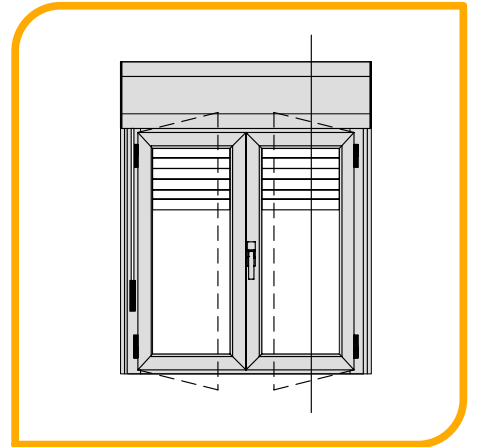
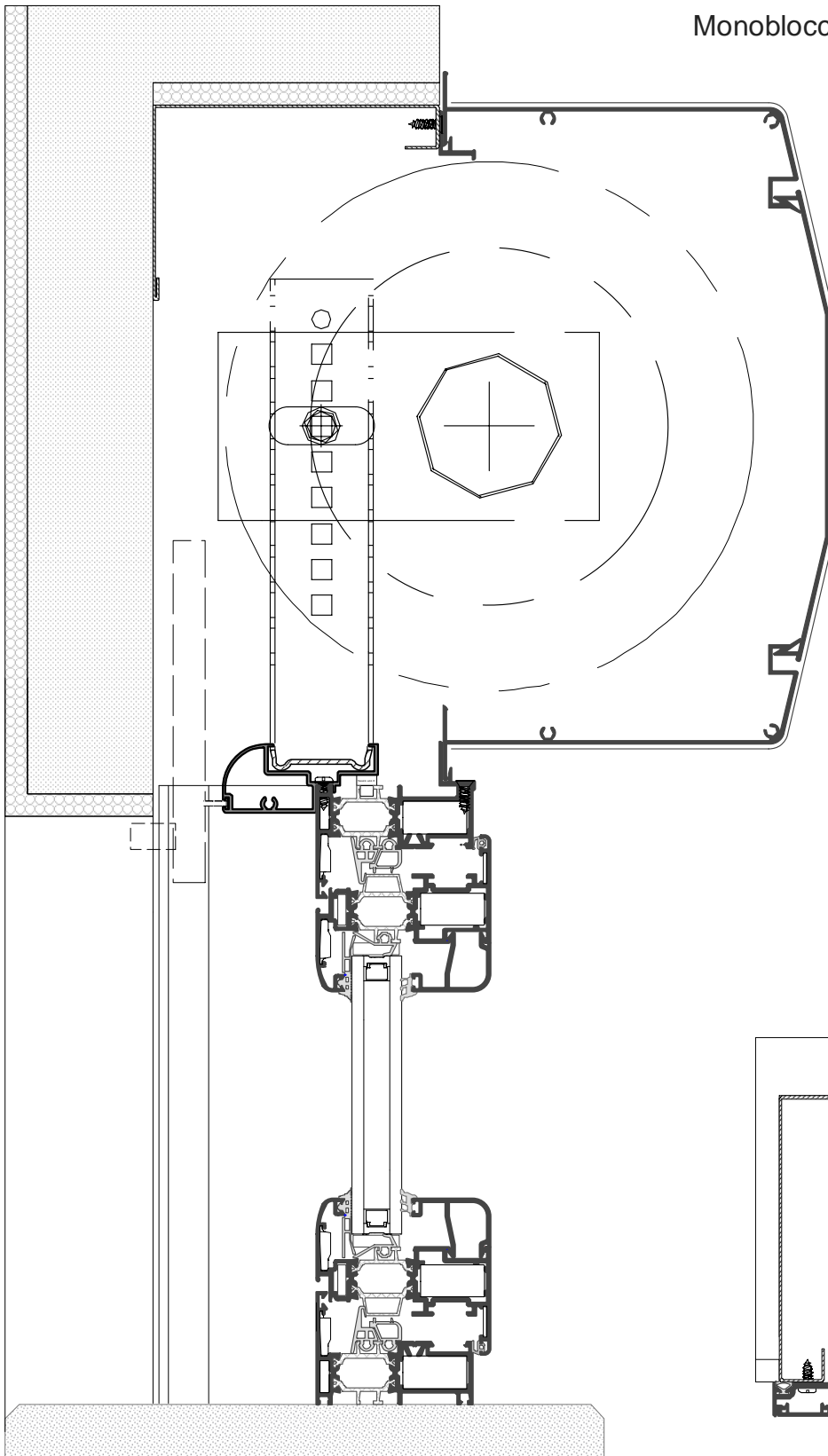

PORTA BALCONE
A 2 ANTE con soglia bassa

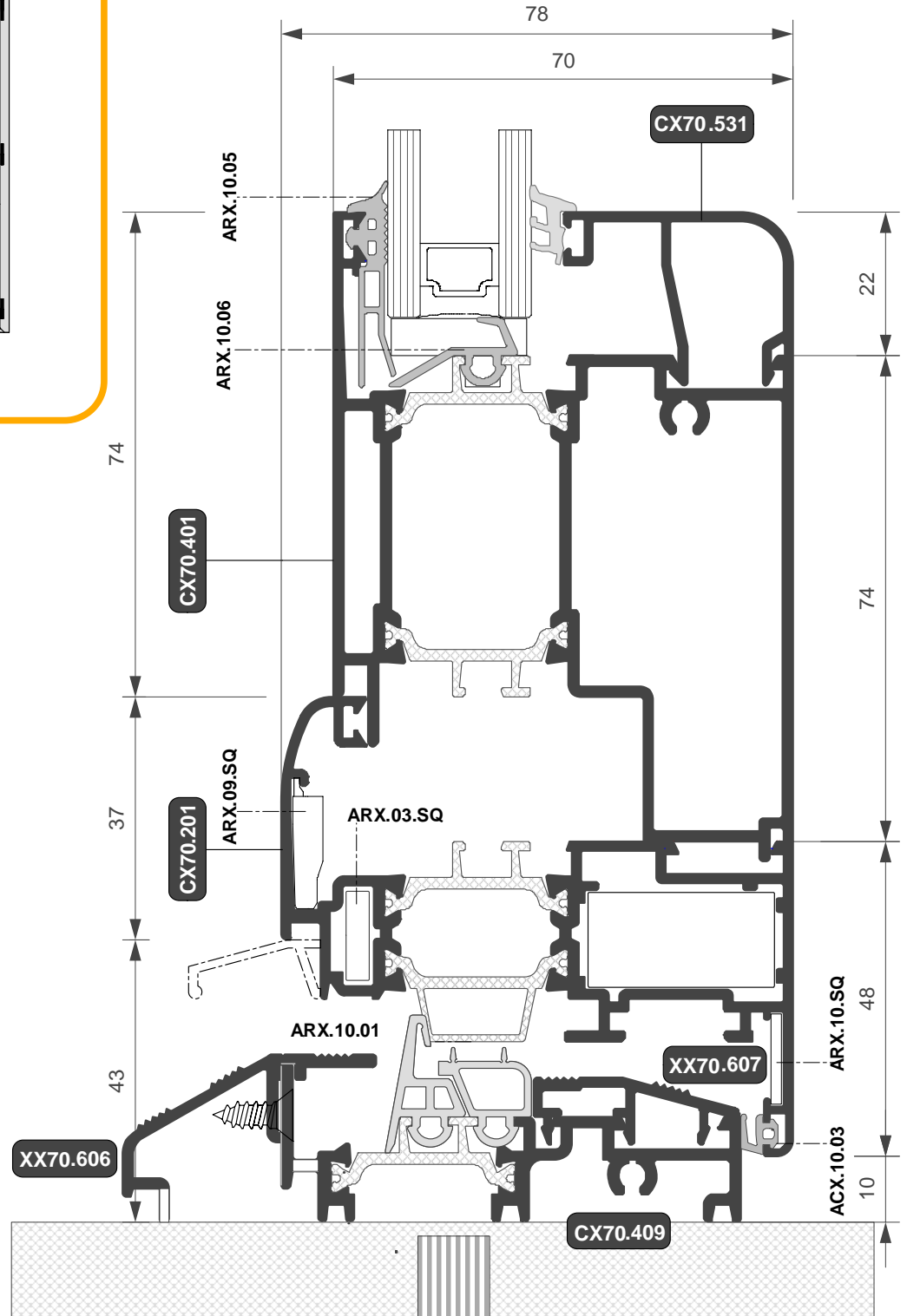
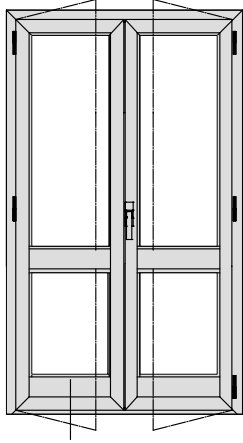

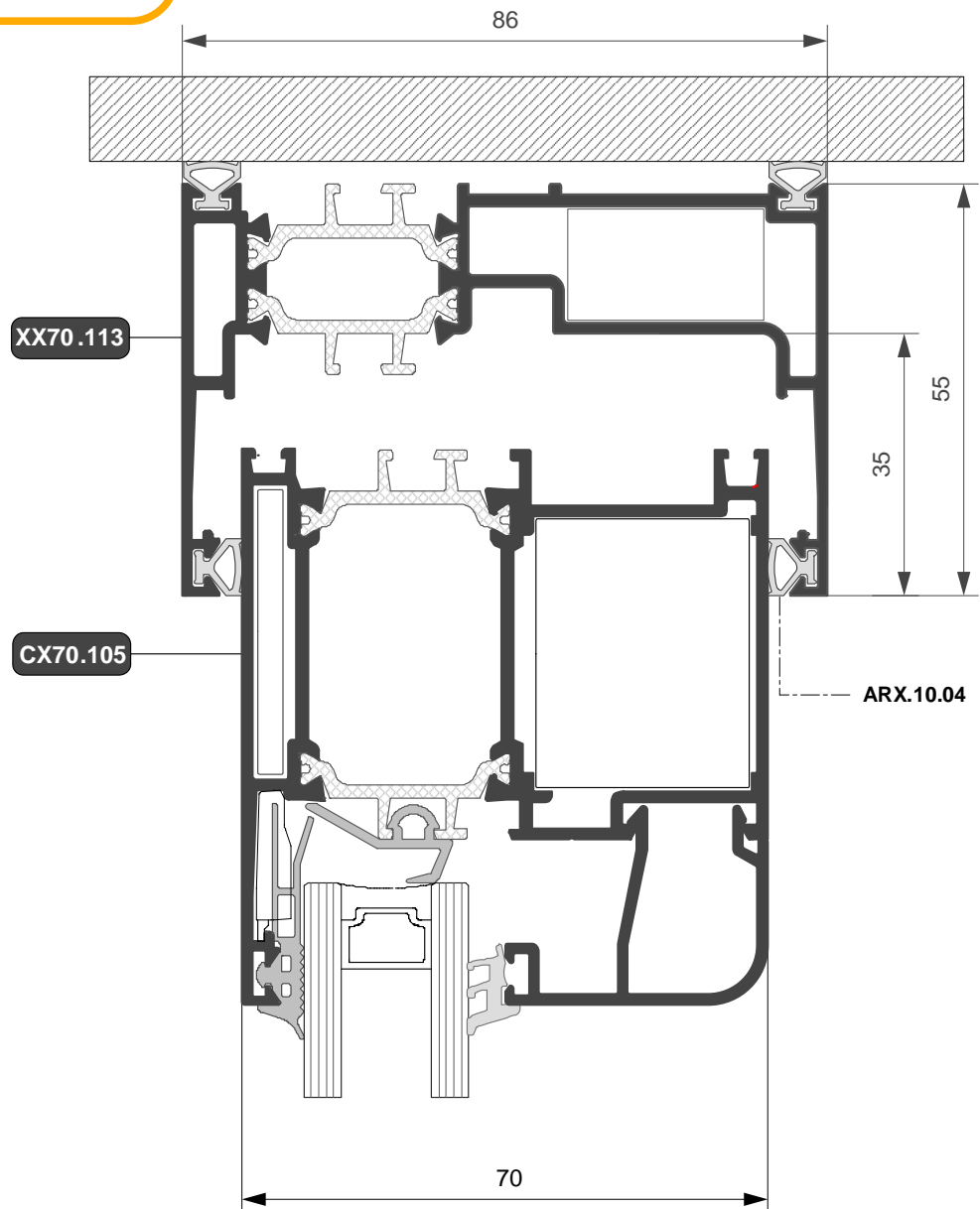
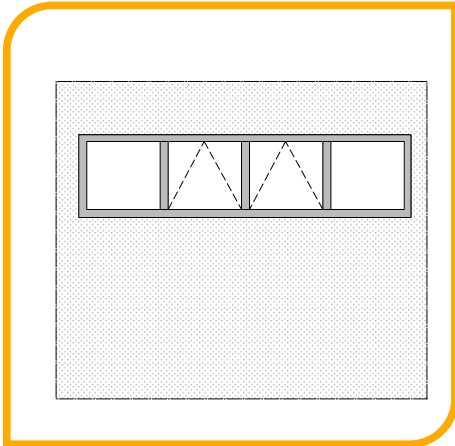

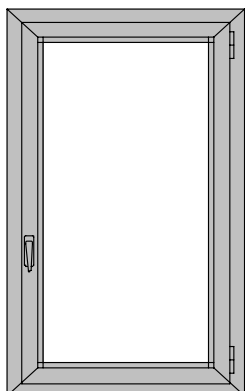

Finestra a 1 anta

Distinta di taglio vetri		
Q.ta	H	L
1	H -150	L -150

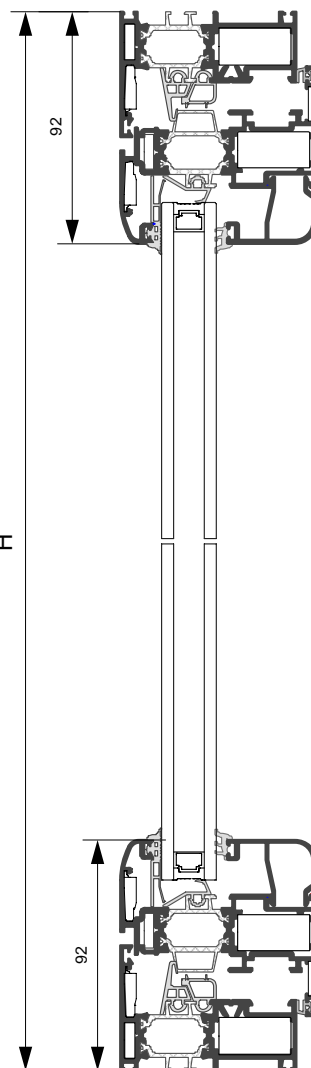
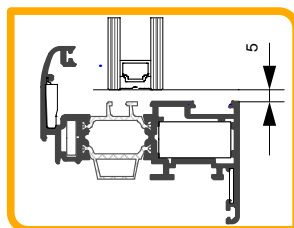

Accessori e guarnizioni

Codice	Descrizione	Q.ta	Codice	Descrizione	Q.ta
ACX.01.SQ	Squadretta a pulsante	8	ACX.05.01	Copriasola scarico acqua	2
ARX.03.SQ	Squadretta cianfrinare est.	8	ACX.06.01	Espansore	*
ARX.09.SQ	Squadretta allin. telaio/anta	8	ACX.07.02	Angolo pressof. fermavetro	4
ARX.10.SQ	Squadretta allin. anta int.	4	ARX.10.01	Guarnizione precamera	2L,2H
ACX.02.01	Cemiera a 2 ali	2	ACX.10.03	Guarnizione battuta	2L,2H
ACX.03.06	Cremonese pressofusa	1	ARX.10.05	Guarnizione vetro esterna	2L,2H
ACX.03.17	Innesti cremonese	2	*	Guarnizione vetro interna	2L,2H
ACX.03.18	Teminale astina	2	ARX.10.02	Angolo guarn. precamera	4
ACX.03.13	Ferrogliera singola	2	ACX.10.11	Guam. suppl. precamera	2L,2H

* secondo dimensioni

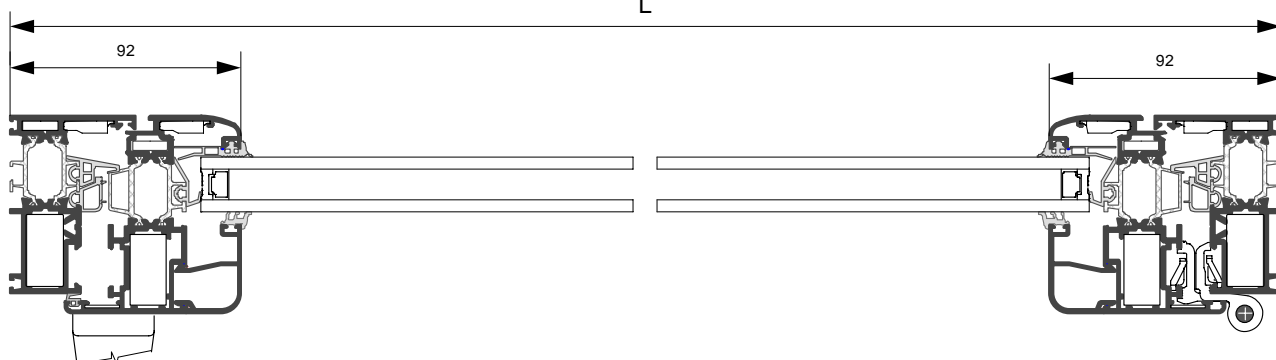

Profilo	Taglio	Q.ta	Profilo	Taglio	Q.ta	Profilo	Taglio	Q.ta
CX70.101	L	2	CX70.531	L - 184	2			
	H	2		H - 184	2			
CX70.201	L - 44	2						
	H - 44	2						

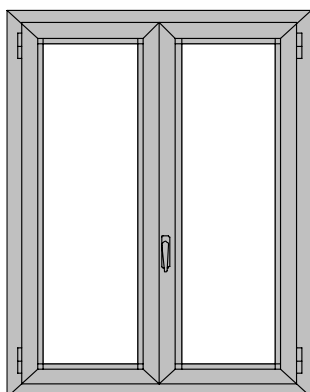

Finestra a 2 ante

Distinta di taglio vetri

Q.ta	H	L
2	H - 150	L/2 - 130.5

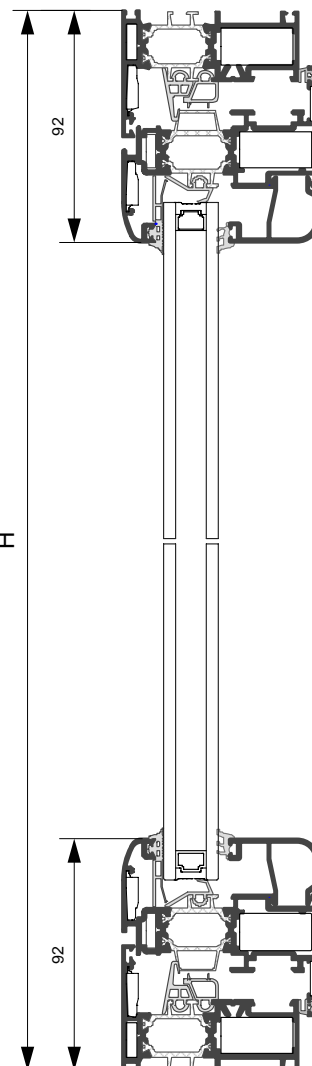
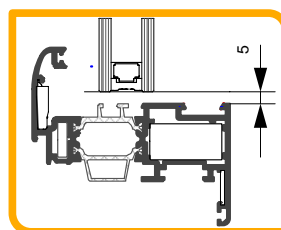

Accessori e guarnizioni

Codice	Descrizione	Q.ta	Codice	Descrizione	Q.ta
ACX.01.SQ	Squadretta a pulsante	12	ACX.04.01	Tappo riporto centrale	1
ARX.03.SQ	Squadretta cianfrinare est.	12	ACX.05.01	Copriasola scarico acqua	2
ARX.09.SQ	Squadretta allin. telaio/anta	12	ACX.06.01	Espansore	*
ARX.10.SQ	Squadretta allin. anta int.	8	ACX.07.02	Angolo pressof. fermavetro	8
ACX.02.01	Cemiera a 2 ali	4	ARX.10.01	Guarnizione precamera	2L,3H
ACX.03.06	Cremonese pressofusa	1	ACX.10.03	Guarnizione battuta	2L,4H
ACX.03.17	Innesti cremonese	2	ACX.10.05	Guarnizione vetro esterna	2L,4H
ACX.03.18	Teminale astina	2	*	Guarnizione vetro interna	2L,4H
ACX.03.11	Paletto a spinta	2	ACX.10.02	Angolo guarn. precamera	4
ACX.03.14	Ferrogliera doppia	2	ACX.10.11	Guam. suppl. precamera	2L,3H

* secondo dimensioni

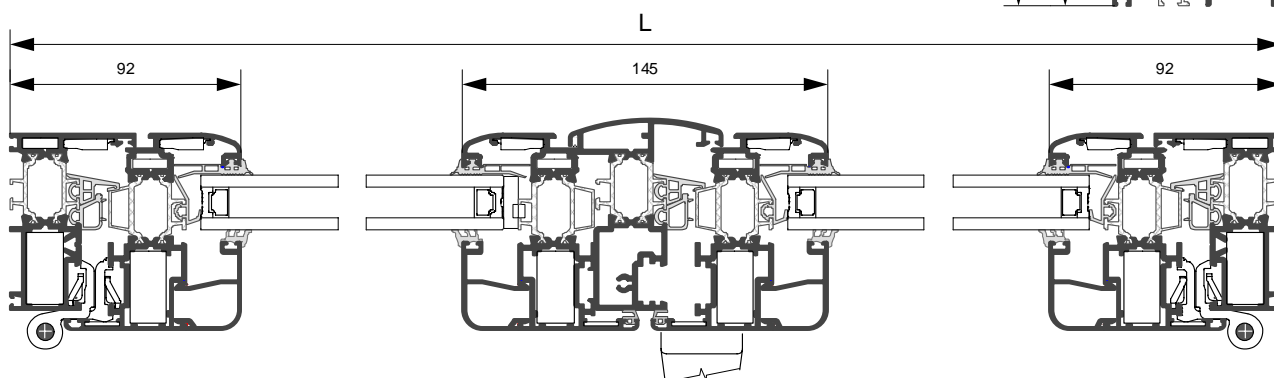

Profilo	Taglio	Q.ta	Profilo	Taglio	Q.ta	Profilo	Taglio	Q.ta
CX70.101	L	2	CX70.531	L/2 - 164.5	4			
	H	2		H - 184	4			
CX70.201	L/2 - 24.5	4	CX70.301	H - 110	1			
	H - 44	4						

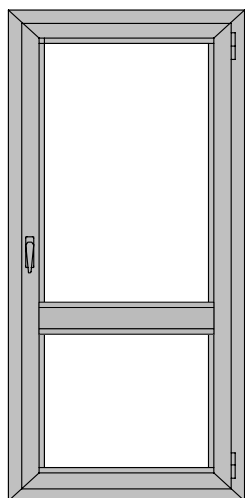

Porta a 1 anta

Distinta di taglio vetri

Q.ta	H	L
1	H-HF-58	L -150
1	HF -154	L -150

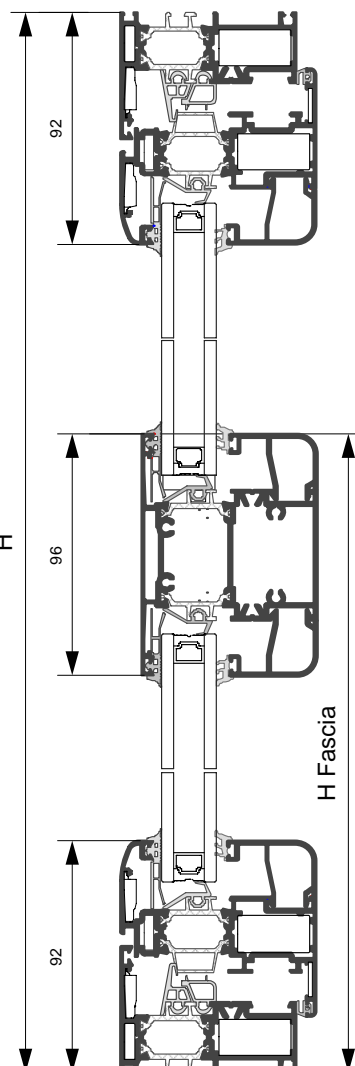
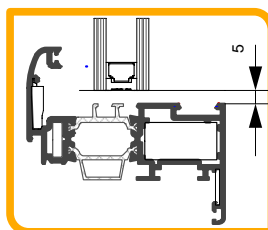

Accessori e guarnizioni

Codice	Descrizione	Q.ta	Codice	Descrizione	Q.ta
ACX.01.SQ	Squadretta a pulsante	8	ACX.05.01	Copriasola scarico acqua	2
ARX.03.SQ	Squadretta cianfrinare est.	8	ACX.06.01	Espansore	*
ARX.09.SQ	Squadretta allin. telaio/anta	8	ACX.07.02	Angolo pressof. fermavetro	8
ARX.10.SQ	Squadretta allin. anta int.	4	ARX.10.01	Guarnizione precamera	2L,2H
ACX.02.01	Cemiera a 2 ali	3	ACX.10.03	Guarnizione battuta	2L,2H
ACX.03.06	Cremonese pressofusa	1	ARX.10.05	Guarnizione vetro esterna	4L,2H
ACX.03.17	Innesti cremonese	2	*	Guarnizione vetro interna	4L,2H
ACX.03.18	Teminale astina	2	ARX.10.02	Angolo guarn. precamera	4
ACX.03.13	Ferrogliera singola	2	ACX.10.11	Guarn. suppl. precamera	2L,2H

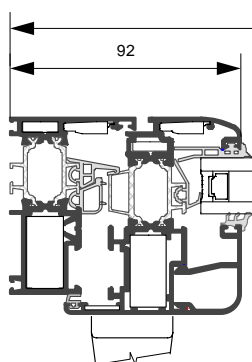
* secondo dimensioni

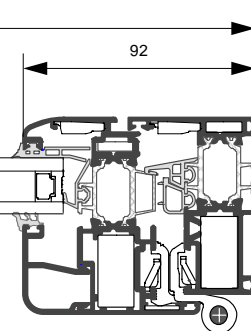

L



Profilo	Taglio	Q.ta	Profilo	Taglio	Q.ta	Profilo	Taglio	Q.ta
CX70.101	L	2	CX60.531	L - 184	4	CX70.402	L - 130	1
	H	2		H - HF - 92	2			
CX70.201	L - 44	2		HF - 188	2			
	H - 44	2						

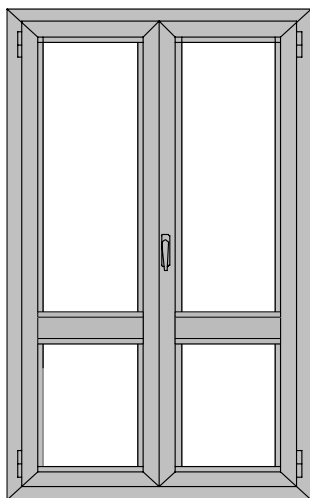

Porta a 2 ante

Distinta di taglio vetri

Q.ta	H	L
1	H-HF-58	L/2 -130.5
1	HF -154	L/2 -130.5

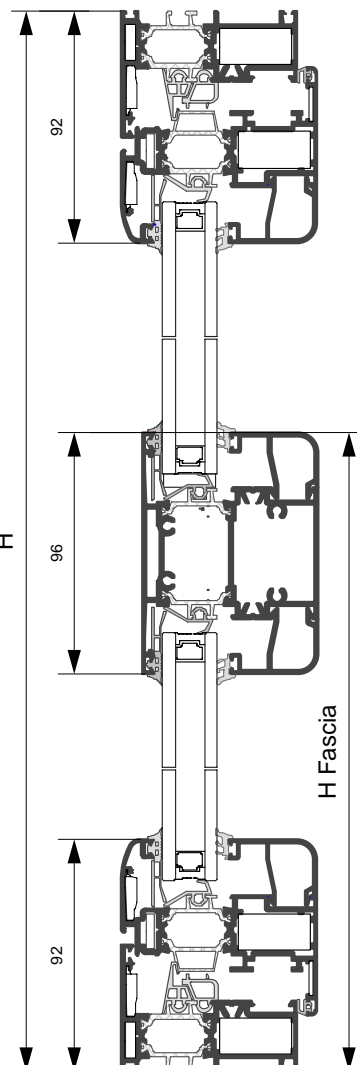
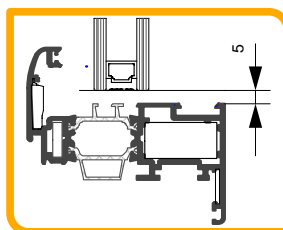

Accessori e guarnizioni

Codice	Descrizione	Q.ta	Codice	Descrizione	Q.ta
ACX.01.SQ	Squadretta a pulsante	12	ACX.04.01	Tappo riporto centrale	1
ARX.03.SQ	Squadretta cianfrinare est.	12	ACX.05.01	Copiasola scarico acqua	2
ARX.09.SQ	Squadretta allin. telaio/anta	12	ACX.06.01	Espansore	*
ARX.10.SQ	Squadretta allin. anta int.	8	ACX.07.02	Angolo pressof. fermavetro	16
ACX.02.01	Cemiera a 2 ali	6	ARX.10.01	Guarnizione precamera	2L,3H
ACX.03.06	Cremonese pressofusa	1	ACX.10.03	Guarnizione battuta	2L,4H
ACX.03.17	Innesti cremonese	2	ARX.10.05	Guarnizione vetro esterna	4L,4H
ACX.03.18	Terminale astina	2	*	Guarnizione vetro interna	4L,4H
ACX.03.11	Paletto a spinta	2	ARX.10.02	Angolo guarn. precamera	4
ACX.03.14	Ferrogliera doppia	2	ACX.10.11	Guam. suppl. precamera	2L,3H

* secondo dimensioni

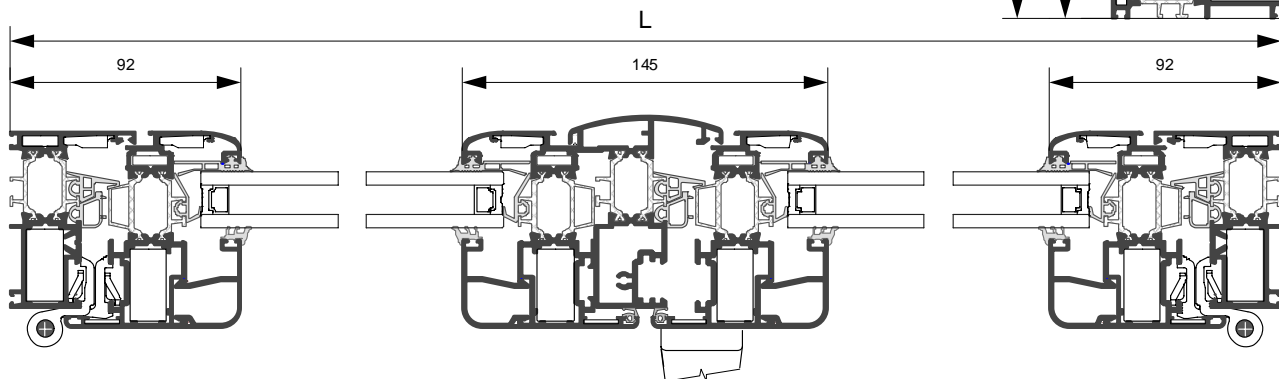

Profilo	Taglio	Q.ta	Profilo	Taglio	Q.ta	Profilo	Taglio	Q.ta
CX70.101	L	2	CX70.531	L/2 - 164.5	8	CX70.301	H - 110	1
	H	2		H - HF - 92	4			
CX70.201	L/2 - 24.5	4		HF - 188	4	CX70.402	L/2 - 110.5	2
	H - 44	2		1				

Attrezzature
ACX.09.01

Descrizione

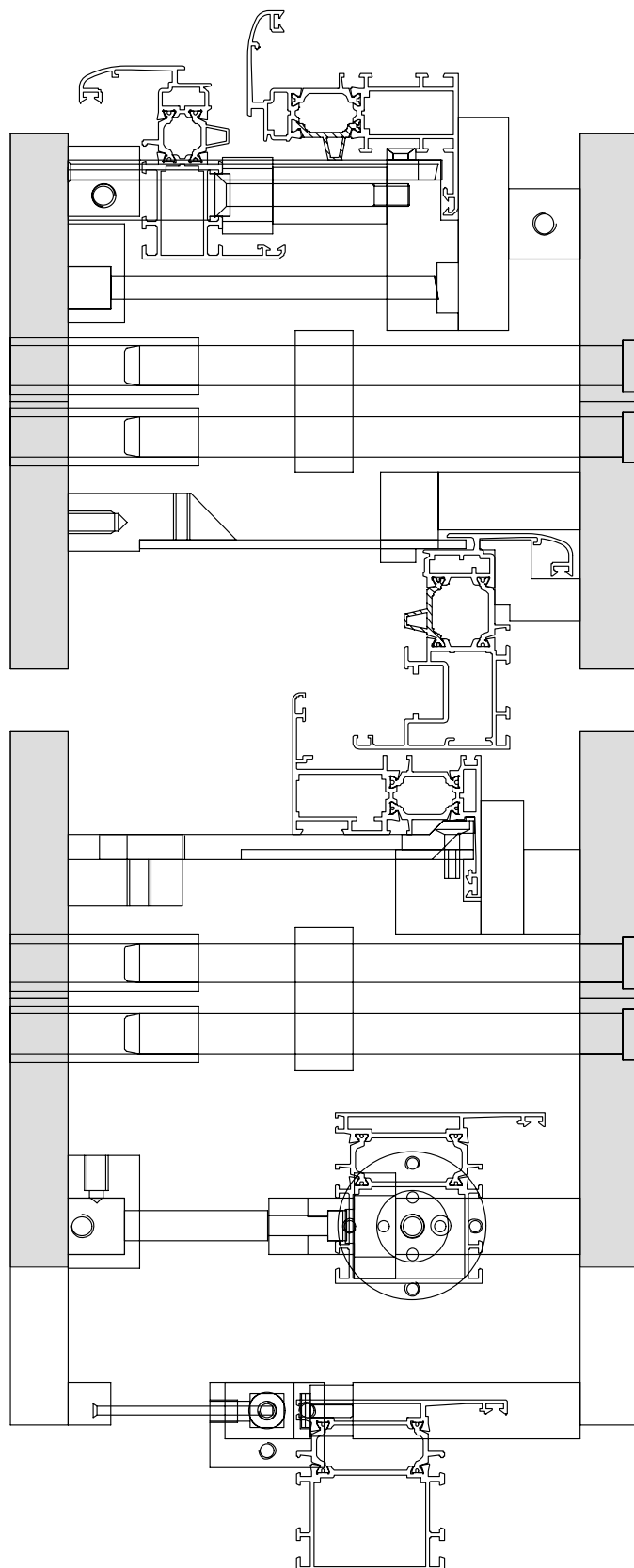
Attrezzatura Pneumatica

CAMERA EUROPEA

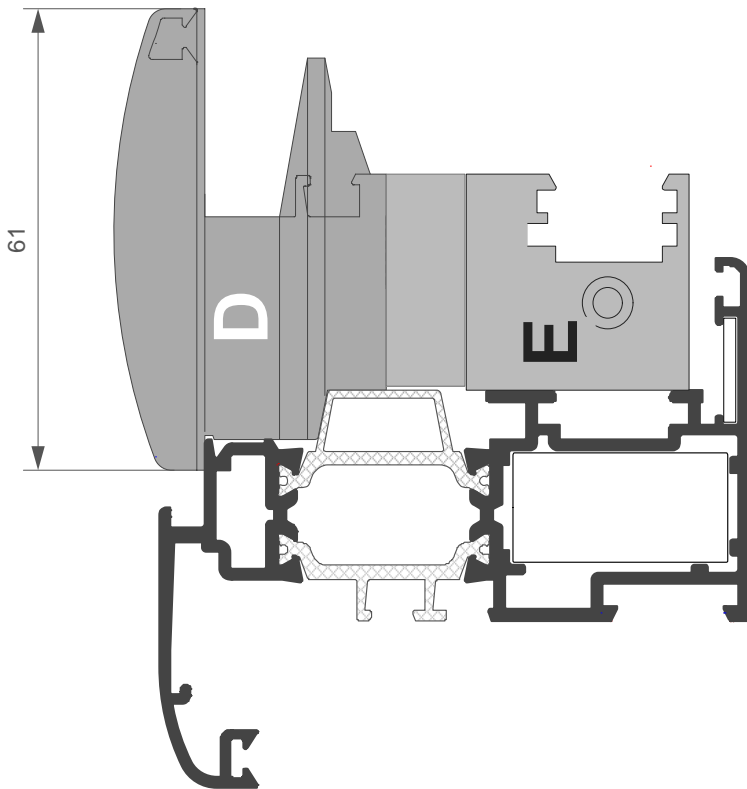

ACX.04.01

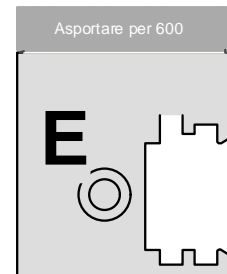
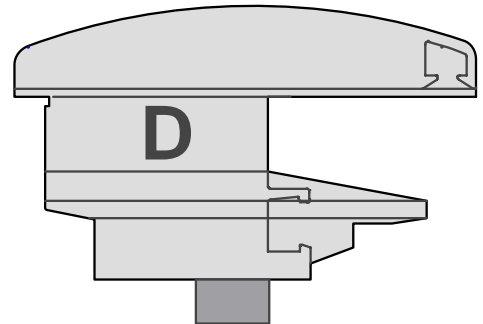

FERRAMENTA A NASTRO

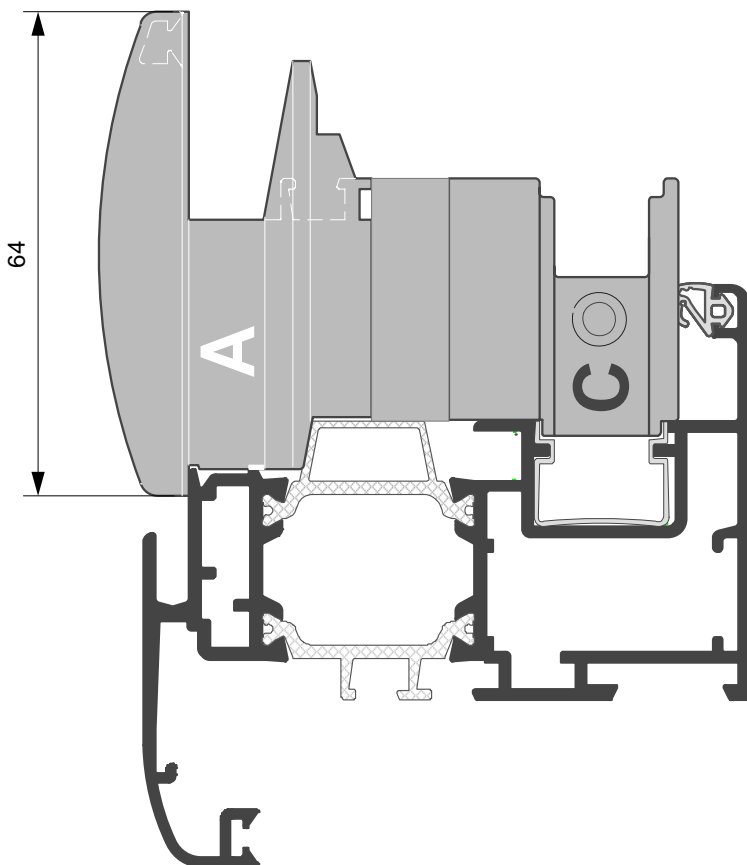

ACX.04.02

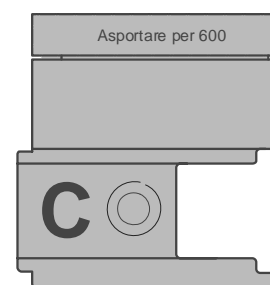
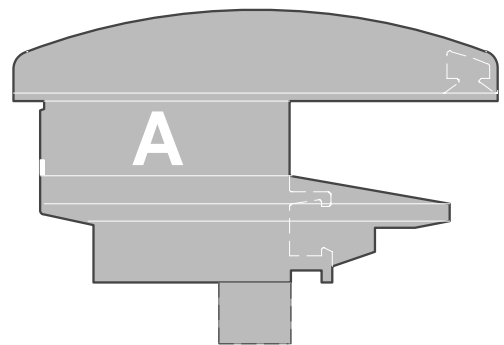

ACX.02.09





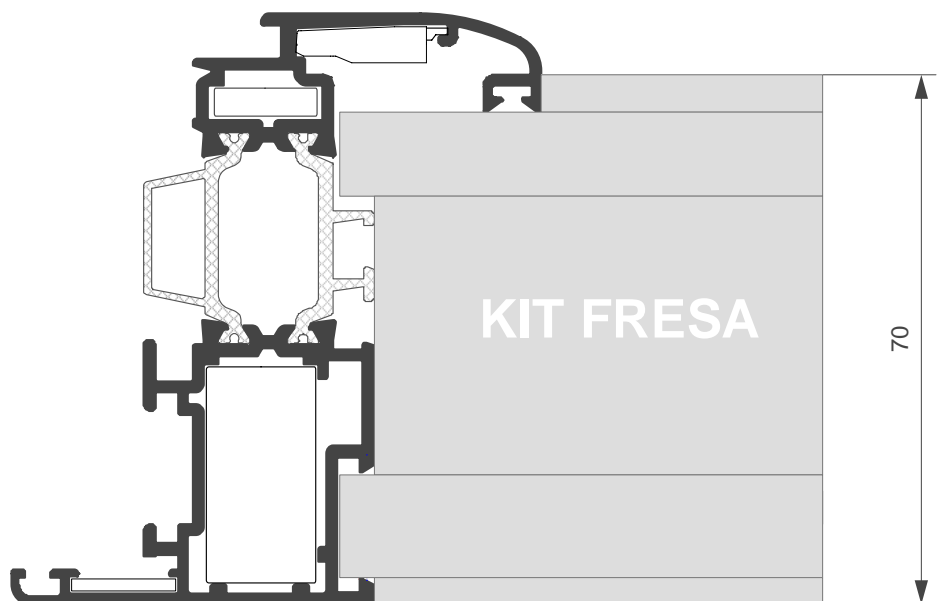
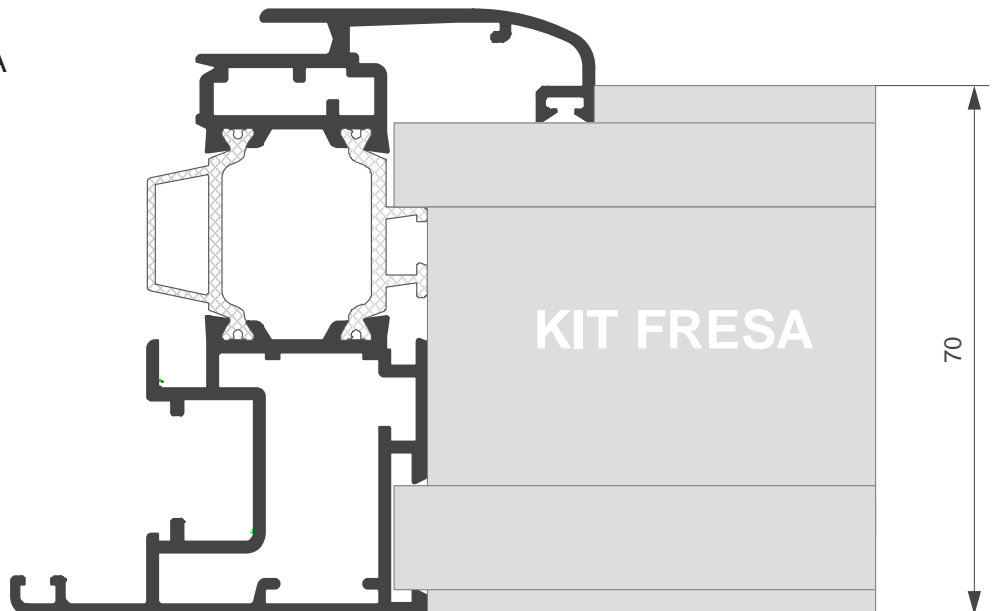
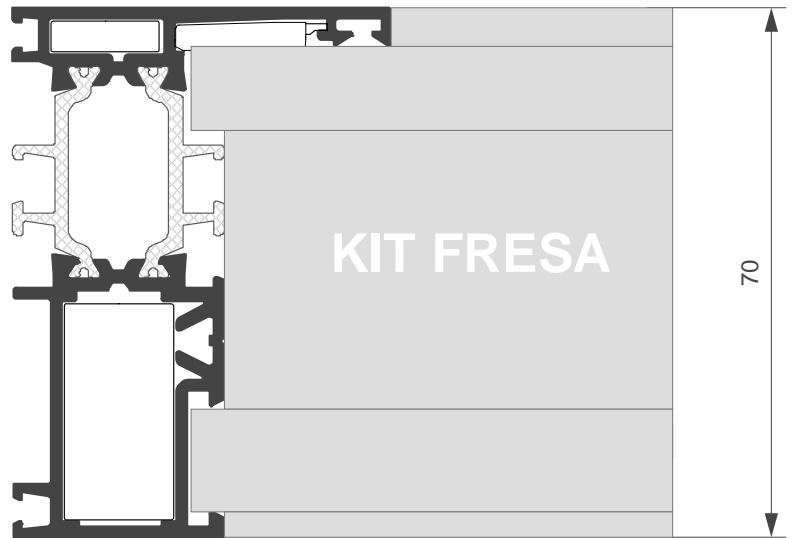



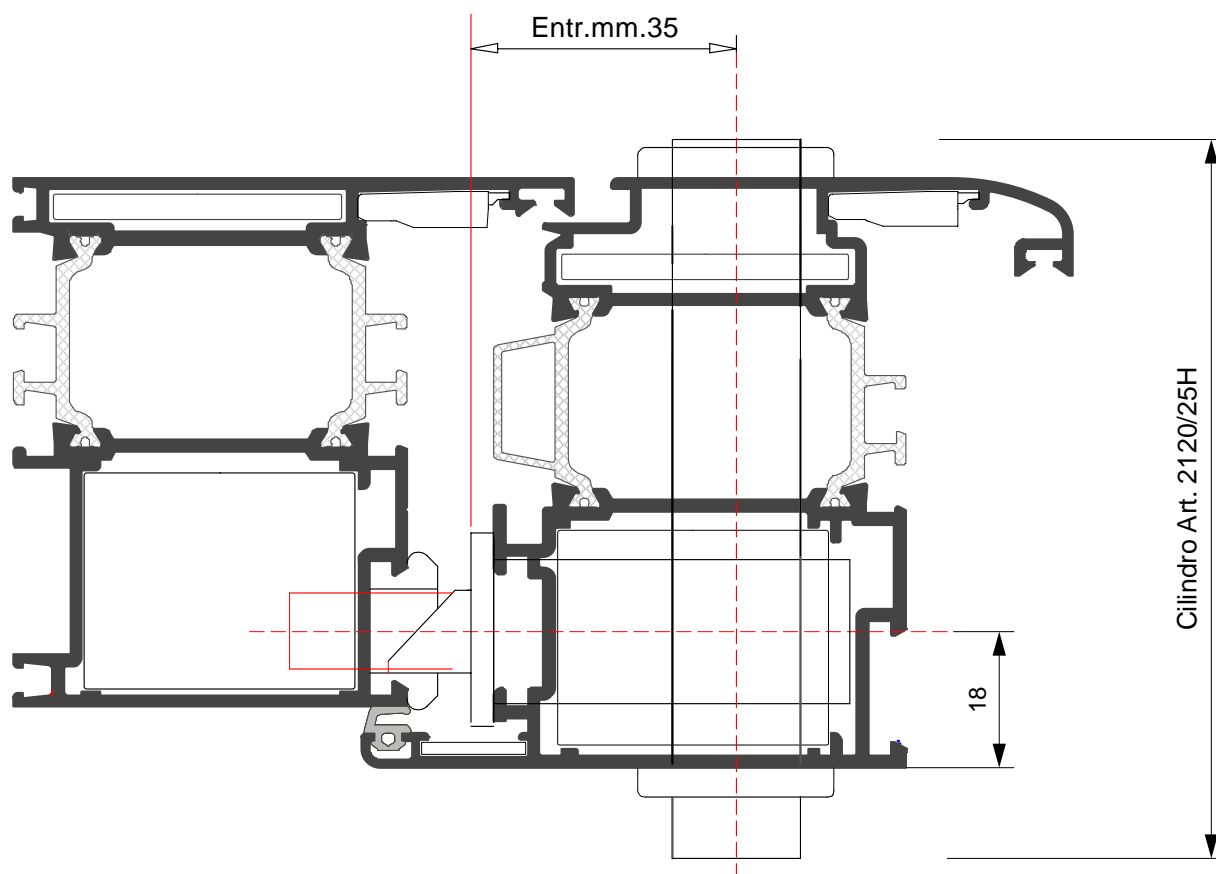

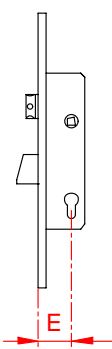
GRUPPI FRESA

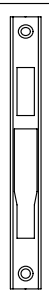
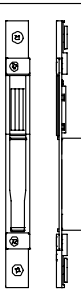

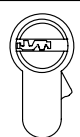
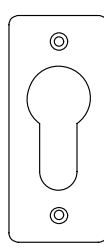

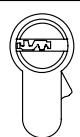

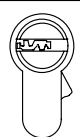
SERRATURE SICUREZZA DA MONTANTE

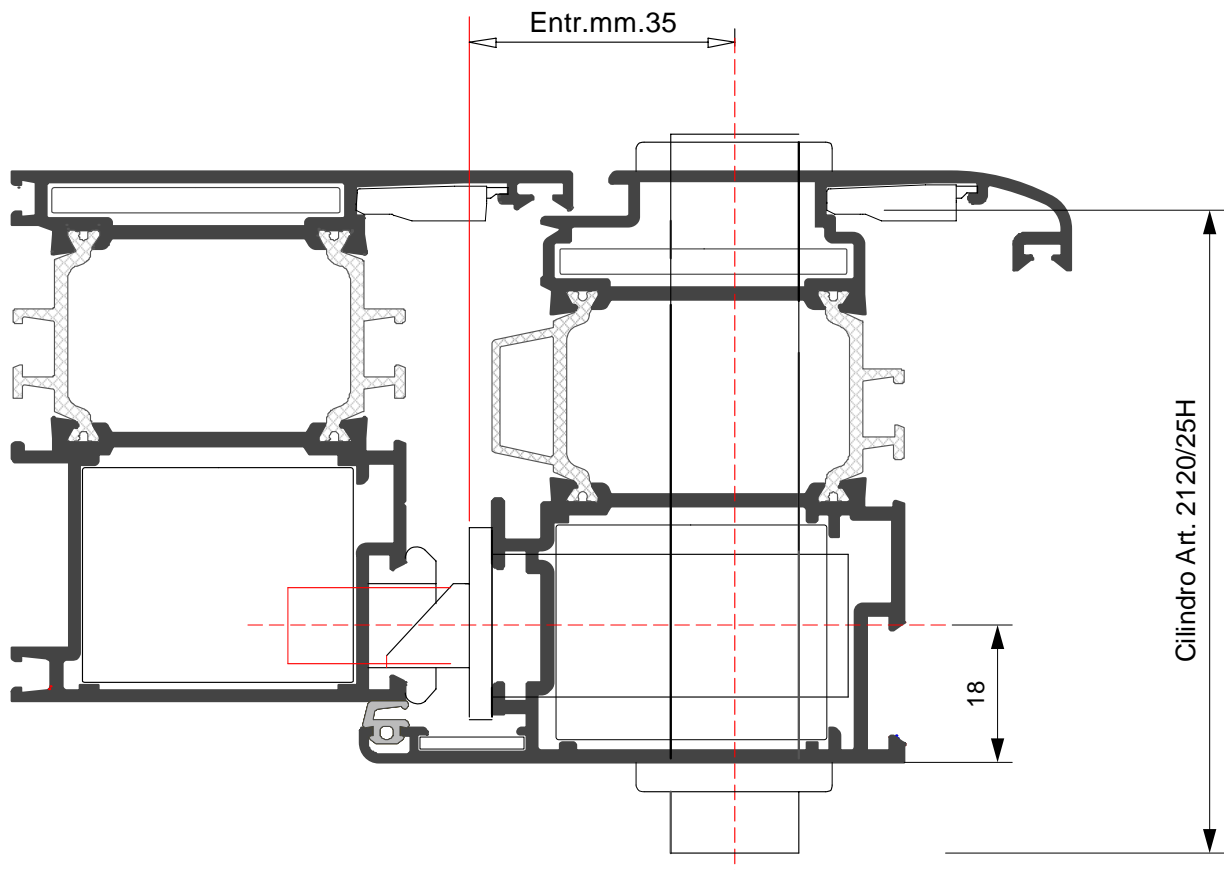

	Serratura E= 35 mm		Contropiastra			Cilindro		Borchia
	Tipologia	Art.	Nylon	Metallo	Registrabile	Tradizionale	Sicurezza	
Catenaccio e scrocco	1450	 02396N	 02396L	 02396X	 Tradizionale	 Sicurezza	 0120N	
Catenaccio e rullo	1455				 Tradizionale	 Sicurezza		
Elettrica con maniglia	1457				 Tradizionale			 Sicurezza

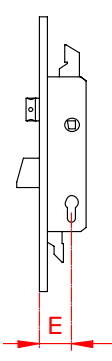

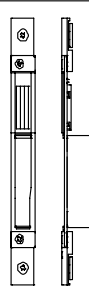

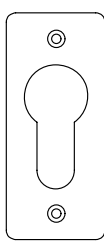
SERRATURE TRIPLICI DI SICUREZZA DA MONTANTE

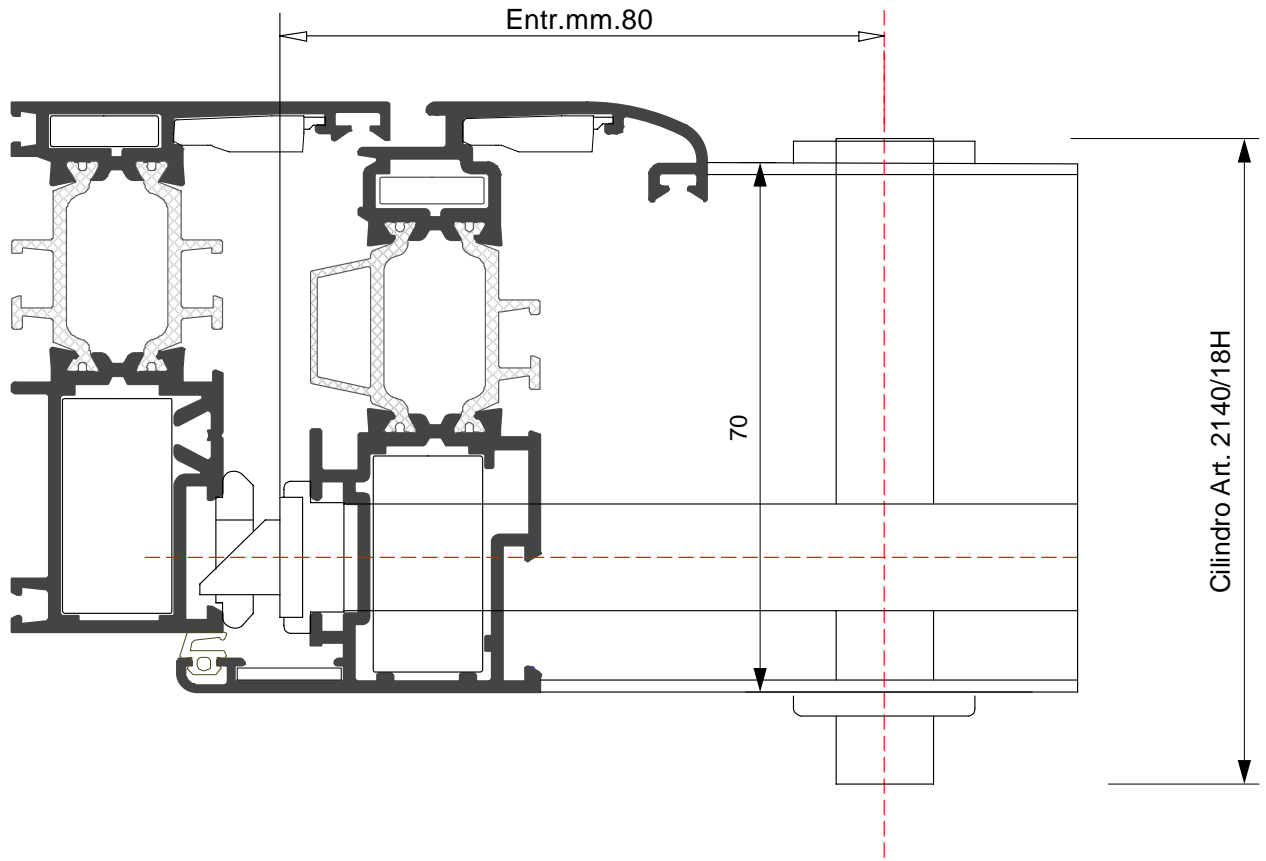

	Serratura E= 35 mm		Contropiastra			Cilindro		Borchia
	Tipologia	Art.	Nylon	Metallo	Registrabile	Tradizionale	Sicurezza	
Catenaccio e scrocco	1480						2120/25H (30+65)	 0120N
Catenaccio e rullo	1485							
Elettrica con maniglia	1487							

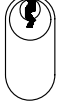
SERRATURE A FASCIA

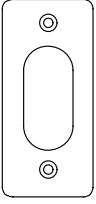
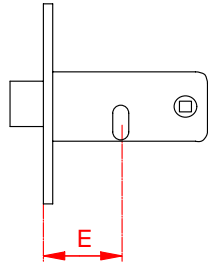

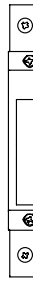
	Serratura E= 80 mm		Contropiastra			Cilindro		Borchia
	Tipologia	Art	Nylon	Metallo	Registrabile			
	Catenaccio e scrocco	880				Tradizionale	Sicurezza	0140N
	Catenaccio e rullo	885				2140/18H (30+50)		
	Elettrica con maniglia	888						
			02381N	02381L	02381X			



